

T. V. Pleteneva, M. A. Morozova,
E. V. Uspenskaya, M. A. Khatchaturyan

DRUGS QUALITY CONTROL



**Federal State Autonomous Educational Institution of Higher Education
«PEOPLES' FRIENDSHIP UNIVERSITY OF RUSSIA»
Department of Pharmaceutical and Toxicological Chemistry**

**DRUGS QUALITY CONTROL
(Theoretical foundation
and practical application)**

The Course book

**Moscow
RUDN University
2019**

УДК 615:658.562(075.8)
ББК 52.82
К65

У т в е р ж д е н о
Р И С У ч е н о г о с о в е т а
Р о с с и й с к о г о у н и в е р с и т е т а
д р у ж б ы н а р о д о в

DOI: <http://dx.doi.org/10.22363/09507-2019>

Контроль качества лекарственных средств (Теоретические основы и практическое применение): учебник /
Т. В. Плетенева, М. А. Морозова, Е. В. Успенская,
М. А. Хачатурян. – Москва : РУДН, 2019. – 226 с. : ил.

В учебнике рассмотрены основы контроля качества лекарственных средств в соответствии с нормативными документами (фармакопеи Европы, США, Японии, РФ) и новыми данными текущей научной периодики, монографий. Подробно изложены особенности физического, спектрального и химического контроля качества лекарственных средств по показателям «подлинность», «чистота» и «количественный анализ». В Части II представлена рабочая тетрадь, включающая вопросы для самоконтроля изученного материала и задачи для лабораторного практикума. Издание содержит справочный материал и образцы фармакопейных статей.

Предназначено для студентов специальности «Фармация».

Drugs quality control (Theoretical foundation and practical application): The Coursebook / T.V. Pleteneva, M.A. Morozova, E.V. Uspenskaya, M.A. Khatchaturyan. — Moscow: RUDN University, 2019 — 226 p.: illustrations

The Course book presents the basics of drugs quality control in accordance with regulatory documents (pharmacopoeia of Europe, USA, Japan, Russia) and new data from current scientific periodicals, monographs The features of the physical, spectral and chemical quality control of medicines according to the indicators «identification», «tests» and «assay» are described in detail. Part II presents a workbook, which includes questions for the self-control of the material studied and tasks for a laboratory workshop. The Course book contains reference material and samples of pharmacopoeial articles.

The Course book is designed for students of the specialty «Pharmacy».

ISBN 978-5-209-0909507-1 © T.V. Pleteneva, M.A. Morozova,
E.V. Uspenskaya, M.A. Khatchaturyan, 2019
© RUDN University, 2019

This work is licensed under the Creative Commons Attribution-ShareAlike 4.0 International License. To view a copy of this license, visit <http://creativecommons.org/licenses/by-sa/4.0/> or send a letter to Creative Commons, PO Box 1866, Mountain View, CA 94042, USA.



PART I. Theory

MODULE 1

GENERAL QUESTIONS OF DRUG ANALYSIS AND QUALITY CONTROL

Topic 1

Common approaches for quality control of drugs. Harmonization of pharmacopoeias

Objective: compare and analyze the equal pharmacopoeial monographs (Ph. Eur., USP, JP) and select optimal methods of quality control for different active substances and excipients.

Every medicine is characterized by special requirements of efficiency and safety, which determine its quality. High-grade medicines and their active substances always comply with all regulatory requirements. Medicine quality control is carried out during the whole manufacturing process (at every stage), also when releasing the drug on the market and during its circulation there.

The process of standardization and quality control is implemented in three main areas: identification of medicines, purity assessment (absence of impurities) and assay. Drugs quality indicators together with the methods of their analysis are stated in special regulatory documents (RD). The main one is Pharmacopoeia.

Pharmacopoeia, or pharmacopoea¹, in its modern technical sense, is a book containing directions for the identification of

¹ The word derives from Ancient Greek **φαρμακοποιία** (pharmacopoiia), from **φαρμακο** – (pharmako-) 'drug', followed by the verb **ποι**-(poi-) 'make' and finally the abstract noun ending **-ια** (-ia). These three elements together can be rendered as 'drug-making'. In Latin, the Greek spellings **φ** (f), **κ** (k) and **οι** (oi) are respectively written as ph, c and œ, giving the spelling pharmacopœia. In UK English, the Latin œ is rendered as oe, giving us the spelling pharmacopoeia, while in American English oe becomes e, giving us the spelling pharmacopeia.

samples and the preparation of compound medicines. It is published by the authority of a government or a medical or pharmaceutical society. Descriptions of preparations are called monographs.

Pharmacopoeia is a collection of official documents (standards and regulations) that sets quality standards for pharmaceutical substances (active pharmaceutical ingredients – API), excipients, diagnostic and medicinal products in different pharmaceutical forms. The provisions of Pharmacopoeia are based on the achievements of pharmaceutical chemistry and pharmaceutical analysis, its criteria, methods and techniques. This document includes instructions for the manufacturing and quality control of pharmaceutical substances, excipients, diagnostic substances and pharmaceutical forms; determines the doses; establishes requirements for medicinal plant materials.

Implementation of Pharmacopoeia standards and requirements combined with the requirements of GMP standards will ensure the quality of pharmaceutical substances and preparations.

Pharmacopoeia has two main sections: general chapters and specific monographs. Specific monographs are devoted to individual substances or finished dosage forms of medicines (USP, JP). Pharmacopoeia monograph is the standard of quality for specific (individual) drug. The general chapters contain information about the methods of analysis, reagents, etc. For example, there are a lot of general chapters in Ph.Eur: Methods of Analysis (Apparatus. Physical and physicochemical methods. Identification. Limit tests. Assays. Biological tests. Biological assays) – Methods in pharmacognosy – Pharmaceutical technical procedures – Materials for Containers – Allergen products – Dosage Forms – Essential oils – Extract – Herbal drugs – Homoeopathic preparations – Immunoserum for human use – Products of fermentation – Radiopharmaceutical preparations – Recombinant DNA technology – Substances for pharmaceutical use – Vaccines for human – Vaccines for veterinary use – Vegetable fatty oils. The State Pharmacopoeia is the official document, which is under state supervision. State Pharmacopoeia is a document of national

legislative power, and its requirements are mandatory for all institutions in the state, engaged in the manufacture, storage and use of medicines, including herbal (medicinal plant materials).

In the world pharmaceutical practice, the recognized leaders among the pharmacopoeias are the Pharmacopoeia of Europe, the United States pharmacopoeia and Japan pharmacopoeia.

The Convention developed and the circle of members Pharmacopoeia expanded. Today its membership includes 36 countries and 22 observers. Russia has observer status.

Members of the European Pharmacopoeia Commission are: Austria, Belgium, Bosnia and Herzegovina, Bulgaria, Croatia, Cyprus, Czech Republic, Denmark, Estonia, Finland, France, Germany, Greece, Hungary, Iceland, Ireland, Italy, Latvia, Lithuania, Luxembourg, Malta, Montenegro, Netherlands, Norway, Poland, Portugal, Romania, Serbia, Slovak Republic, Slovenia, Spain, Sweden, Switzerland, the former Yugoslav Republic of Macedonia, Turkey, United Kingdom and the European Union. The observers to the European Pharmacopoeia Commission are: Albania, Algeria, Australia, Belarus, Brazil, Canada, China, Georgia, Israel, Madagascar, Malaysia, Morocco, Republic of Kazakhstan, Russian Federation, Senegal, Syria, Tunisia, Ukraine, United States of America and WHO (World Health Organization).

Since 1975 if the country wishes to register its products in the European Union it has to use the European Pharmacopoeia. The network of analytical laboratories, controlled by the European Pharmacopoeia Directorate, was organized in 1994. In the same year the attestation procedure for pharmaceutical substances conformity to the demands of European Pharmacopoeia monographs has been introduced.

Now a new Ph. Eur. edition is published every three years and additional Updates – every few months. The 7th edition of Ph. Eur. has come into force since 2011. The European Pharmacopoeia has a classic structure and includes both types of monographs. But its peculiarity is that, unlike the USP and BP, it does not contain monographs for dosage forms. It presents the monographs only for substances.

Standards of European Pharmacopoeia were widely used in Russian Federation until recently, when they found a reflection in the Russian Pharmacopoeia XIII. European Pharmacopoeia is also being used as a national standard in some countries of the former Soviet Union.

The European Pharmacopoeia is published by the Directorate for the Quality of Medicines & HealthCare of the Council of Europe (EDQM). Commission of European Pharmacopoeia, which includes all members and observers, also regulates work on Ph. Eur. Commission meets three times a year. During the rest year, its work is led by elected Bureau. Its functions include the work program adoption, definition of expert groups as well as pharmacopoeia texts approval.

After each monograph has been approved, special group of experts regulates it. The group works according to prescribed control procedures, technology development and revision of pharmacopoeia monographs.

The proposals from national delegations, expert groups, and pharmaceutical industry representatives replenish Ph. Eur. The decision on new monograph inclusion depends on the therapeutic effect of drug, widespread of it use, on the number of countries that have ratified it and on its proven quality.

The first edition of the United States Pharmacopoeia – National Formulary (USP – NF) was published in 1820. Current edition is USP 42-NF 37 (2019). It came into force on May 1, 2011. This is the most dynamically developing Pharmacopoeial standard. This document, as its name implies, is really a collection that includes two different standards: Pharmacopoeia and National Formulary. The latter pertains to some excipients and other substances that are not drugs. USP – NF produced by the only world's non-government organization US Pharmacopoeia Convention. However the requirements of this standard shall be approved at the state level. They determine the minimum level of quality required for organizations producing or supplying drugs in the United States.

US Pharmacopoeia Convention is one of the most influential pharmacopoeia organizations in the world. Its quality stan-

dards are not only introduced in the US and Canada, but are also put into service in a number of countries actively producing drugs (India, China, etc). USA Pharmacopoeia Convention is a nonprofit organization, but its financial resources and influence are very high over the world. Convention publishes a number of periodicals devoted to drug quality standards, develops and sells worldwide a rich collection of pharmacopoeia chemical reference materials, which quality is recognized all over the world.

Japanese Pharmacopoeia (JP) is another leading international pharmacopoeia. The new edition is published every five years. Current edition (JP 17) came in 2016. JP is published not only in Japanese but also in English.

British Pharmacopoeia (BP) has been published since 1864, the current edition – BP 2019. BP operates in the United Kingdom simultaneously with the European Pharmacopoeia. BP monographs for substances are practically the same as the corresponding Ph. Eur. monographs. BP also contains monographs for finished dosage forms of medicines.

In addition, the World Health Organization since 1950 publishes the International Pharmacopoeia. Today it is represented by the 8th edition, published in 2018. The main objective of the International Pharmacopoeia is to maintain the medicines quality in developing countries. In the absence of state resources to develop their own pharmacopoeia, these countries can take the International Pharmacopoeia as a national one.

The XIV edition of Russian Federation (Ph.RF) State Pharmacopoeia was published in 2018. Monographs describe physical and chemical characteristics of different dosage forms, analysis methods, demands for drug quality indicators. Monographs defines the quality requirements of medicines, active pharmaceutical substances and excipients.

Harmonization of pharmacopoeias. Increased facilities for travel have brought into greater prominence the importance of an approach to uniformity in the formulae of the more powerful remedies, in order to avoid danger to patients when a prescription is dispensed in a different country from that in which it was

written. The first attempts were made by international pharmaceutical and medical conferences to settle a basis on which an international pharmacopoeia could be prepared, but due to national jealousies and the attempt to include too many preparations nothing has yet been achieved.

Globalization processes indicated the need for harmonization of medicines quality requirements. Harmonisation of various countries pharmacopoeia requirements is determined by ICH (www.ich.org) – the International Conference on Harmonization of Medicines Quality and the International Conference on Harmonisation of Technical Requirements for Registration of Pharmaceuticals for Human Use. The World Health Organization and three leading Pharmacopoeias (Ph. Eur, USP, JP) are directly involved in ICH activity. The purpose of ICH is to develop common requirements for standardization, quality control, efficiency, safety, production and registration of medicines. Representatives from three leading Pharmacopoeias meet twice a year since 1990 in the Pharmacopoeial Discussion Group to try to work towards «compendial harmonisation». Specific monographs are proposed, and if accepted, proceed through the stages of review and consultation. Adoption of a common monograph provides a common set of tests and specifications for a specific material. Not surprisingly, this is a slow process.

Though formerly printed there has been a transition to a situation where pharmaceutical information is available as printed volumes and on the internet. The rapid increase in knowledge renders necessary frequent new editions, to furnish definite formulae for preparations that have already come into extensive use in medical practice, so as to ensure uniformity of strength, and to give the characters and tests by which their purity and potency may be determined. However each new edition requires several years to carry out numerous experiments for devising suitable formulae, so that current pharmacopoeia is never quite up to date.

General monographs of Ph. Eur. «Pharmacopoeial harmonization» states: «It provides information on the degree of harmonization and consequently interchangeability of various

general chapters and monographs of the European Pharmacopoeia and those of the Japanese Pharmacopoeia and United States Pharmacopoeia».

The European Pharmacopoeia Commission recognizes the utility of working with other pharmacopoeial bodies to develop harmonized monographs and general chapters. Such harmonization is fully compatible with the declared aims of the Commission and has benefits of different kinds, notably the simplification and rationalization of quality control methods and license in procedures. Such harmonization also enhances the benefits of the work of the International Conference on Harmonization (ICH) and the Veterinary International Cooperation on Harmonization (VICH) since some of the guidelines developed depend on pharmacopoeial general chapters for their application.

Harmonization is carried out in the Pharmacopoeial Discussion Group (PDG), in which the European Pharmacopoeia, the Japanese Pharmacopoeia and the United States Pharmacopoeia are associated. Where harmonization of monographs is carried out, the aim is to arrive at identical requirements for all attributes of a product. For some products, it can be extremely difficult to achieve complete harmonization, for example because of differences in legal status and interpretation.

Anniversary of the Pharmacopoeia Convention and marks the occupation of the new purpose – designed headquarters building of the EDQM, the European Directorate for the Quality of Medicines & Health Care, in Strasbourg.

The monographs of the Pharmacopoeia, both specific and general, together with other texts made mandatory by virtue of reference in monographs, are applicable throughout the 37 Member States including the European Union itself, which is also a signatory to the European Pharmacopoeia Convention. This means that the European Pharmacopoeia holds a special place in the regulatory processes within the European Union, its text being made mandatory or given ‘mandatory’ applicability by virtue of reference in European Council Directives. In addition to the 37 signatories to the European Pharmacopoeia Convention,

there are also a large number (20) of observer countries. Consequently, the quality standards developed through the Pharmacopoeia have an impact on the quality of medicinal products and substances used across a large part of the globe.

The cooperation between the experts from industry, academia, regulatory authorities and official government laboratory scientists represents the pinnacle of scientific cooperation to produce a high standard of technical monographs and chapters.

Topic 2

Pharmaceutical analysis data treatment. Validation of analytical procedures

Objective: to get an idea about the rules of pharmaceutical analysis data treatment and reporting, the scope and process of validation of analytical procedures, consolidate knowledge in problem solving and laboratory work.

Analytical signals treatment and transformation into the analytical data concerning the nature and amount of a substance, its chemical structure or spatial location of the sample are important components of the pharmaceutical analysis. The result of analysis not statistically treated is of little value.

According to the pharmacopoeial and GMP requirements analytical procedures used for drugs quality control should be validated.

The purpose of validation process is to confirmation experimentally that the analytical procedure provides relevant and reliable information about the object of analysis, and is suitable for its intended purpose.

All quantitative tests (assays) should be validated, including impurities limit tests. Identification tests are validated if it is necessary to confirm their specificity.

Validation of analytical procedures (especially those that will be used as the official process) is regulated by series of standards issued by National and International organizations:

- Russian State Pharmacopoeia XII OFS 42-0113-09 «Validation of Analytical Procedures»
- USP <1225> Validation of Compendial Procedures
- ICH (Q2A, Q2B) Validation of Analytical Procedures: Text and Methodology.

Validation of analytical methods should be evaluated on the following characteristics – the validation parameters:

- Accuracy;
- Precision;
- Specificity;
- Detection Limit;
- Quantitation Limit;
- Linearity;
- Range;
- Robustness.

Guidelines for choosing the parameters of validation are shown in Table 2.1.

Table 2.1

Analytical procedure's characteristics, evaluated in the validation

Performance characteristic	Analytical Tests				
	Identification tests	Impurities		Assays	
		Quantification tests	Limits tests	Active substance, standardized components	Active substance in Dissolution test
Specificity**	Yes	*	*	Yes	Yes
Detection Limit	No	No	Yes	No	No
Quantitation Limit	No	Yes	No	No	No
Range	No	Yes	No	Yes	Yes
Linearity	No	Yes	No	Yes	Yes
Accuracy	No	Yes	*	Yes	Yes
Precision:					
– Repeatability	No	Yes	No	Yes	Yes
– Intermediate Precision	No	Yes	No	Yes	No
Robustness	No	*	*	*	*

Notice: * – may be required, depending on the nature of the specific test; ** – the lack of specificity of one analytical procedure can be compensated using the other analytical procedure.

Revalidation of an analytical procedure is performed in case of:

- changes in drug manufacturing process (the object of analysis);
- changes in the drug's composition;
- changes in the previously approved analytical procedure.

Trueness with regard to a set of measurements involves a combination of two components: **Accuracy** and **Precision**.

Accuracy is characterized by the closeness of the test result obtained by the procedure to the true value (Fig. 2.1). The value of the *bias* (systematic error) is an indicator of the accuracy. An analytical procedure to be validated is recognized accurate, if the values accepted as conventionally true are within the confidence intervals of the relevant average tests results obtained by this procedure.

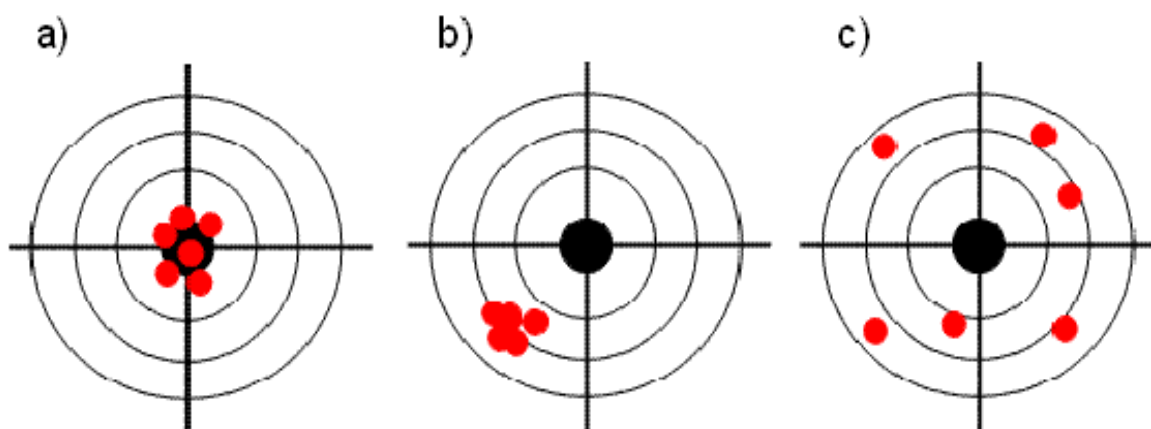

Fig. 2.1. **The accuracy and precision:**

- a) and b) high precision; b) high accuracy in addition;
- c) the low accuracy and precision.

Black circle indicates that the measured value is accepted to be true
(*AL Pomerantsev, Russian Chemometrics Society,*
<http://rcs.chph.ras.ru>)

There are different approaches for assessing the accuracy of quantitative tests (assays):

- a) analysis by validated procedure using Reference Standards (RS) or model mixtures to which known quantities (concentration) of the drug substance to be analyzed;

b) comparison of the results of the proposed analytical procedure with those of a second well-characterized procedure, the accuracy of which is stated and/or defined;

c) consideration the results linearity of proposed analytical procedure: if the absolute term of equation $y = b \times x + a$ is not statistically different from zero, then the use of this procedures give results free of bias.

Precision is characterized by the scattering of the results obtained by the procedure to the average value (Fig. 1). This characteristic depends only on random factors and not connected with the true value to be measured. The Measure of this scattering is the *standard deviation* of individual measurement obtained for a sufficiently large amount of sampling.

Precision is assessed for all quantitative tests (assay) using the results of at least three determinations for 3 levels of values to be measured (lower, middle and upper), which are within the range. In many cases, the precision can be evaluated based on the experimental data by least square method.

Precision study is performed using homogeneous samples and can be assessed in three ways:

- as repeatability;
- as within-laboratory (intermediate) precision;
- as between-laboratory reproducibility (precision).

The results of analytical procedures estimation for each of the options are usually characterized by the corresponding value of the Standard Deviation of individual determination with the number of degrees of freedom.

Usually the repeatability of the results obtained by the original procedure is estimated in the development process. In case of inclusion of the developed analytical procedure in normative document, within-laboratory (intermediate) precision should be estimated additionally. Between-laboratory reproducibility (precision) of analytical procedure should be estimated with its proposed inclusion in the General Pharmacopoeial Article, Pharmacopoeial Article or RS normative document.

Repeatability is assessed by individual measurements results obtained in the same laboratory conditions (the same operators, the same equipment or reagents within a short period of

time) (Fig. 1). Repeatability is estimated by the relative standard deviation (RSD), which should not exceed 2%.

Between-laboratory reproducibility (precision) of an analytical procedure characterizes the measure of agreement of the results obtained by the same method on identical samples in different laboratories, by different operators and different analytical instruments. It is estimated by the RSD, which should not exceed 3%.

Within-laboratory (intermediate) precision is estimated in work conditions of a single laboratory (different days, different operators, different equipment, etc.).

The trueness of the analysis as a whole and its individual components: accuracy and precision can vary greatly depending on the sample composition.

With the analyte's content decreasing and with the content of impurities increasing the trueness decreases; at some point its quantitative determination and then identification becomes impossible. The efficiency of proposed procedure in such «extreme» analytical conditions is characterized by the **Sensitivity** and **Specificity**.

The characteristic of an analytical procedure, connected with the possible identification or detection of analyte within the range of its small amounts is called **Sensitivity** and in the presence of other components – **Specificity**. Let's consider the basic numerical characteristics of sensitivity and specificity.

Sensitivity is characterized by Detection and Quantitation Limits.

Detection Limit (Limit of Detection, LOD) is the lowest amount of analyte in a sample that can be detected, but not necessarily quantitated, under the stated experimental conditions. Thus, limit tests merely substantiate that the amount of analyte is above or below a certain level. The detection limit is usually expressed as the concentration of analyte (e.g., percentage, ppb) in the sample. Thus, the LOD characterizes the procedures in terms of a qualitative analysis.

Depending on the type of procedure (visual or instrumental) different methods are used for LOD estimation. For the procedures with visual result assessment LOD is estimated by the analysis of samples with known concentrations of analyte and

minimum analyte content, which can be determined by proposal procedure.

For the procedures with instrumental result assessment LOD is calculated using either the signal/noise ratio, or using standard deviation of analytical signal and the slope of the calibration curve.

For the calculation using analytical signal/noise level ratio it is necessary to determine the minimum amount (concentration) of the analyte in the sample, in which the signal/noise ratio is in the range of 3 to 5; in the second case LOD is calculated from the equation:

$$\text{LOD} = 3,3 \times S/b,$$

where S – standard deviation of the analytical signal;

b – coefficient of sensitivity, which is the ratio of the analytical signal to value to be determined, the slope of the calibration curve $y = b \times x + a$.

If there are experimental data in a wide range of the measured values, S and b can be estimated by least square method. Generally, if there is evidence that procedure is suitable for reliable detection of the analyte in the range of its concentrations both above and below the norm of its content established specification, the LOD calculation is not required.

Quantitation Limit (Limit of Quantitation, LOQ) is the lowest amount of analyte in a sample which can be quantitatively determined with required within-laboratory (intermediate) precision and accuracy. The LOQ is a parameter of quantitative assays for low levels of compounds in sample matrices, and is used particularly for the determination of impurities and/or degradation products, LOQ is expressed as the concentration of analyte (e.g., percentage, ppm) in the sample.

For the procedures with visual result assessment LOQ is estimated by the analysis of samples with various known concentrations of analyte and determine the minimum value at which the analysis result can be obtained visually with the required accuracy and within-laboratory (intermediate) precision.

For the procedures with instrumental result assessment LOQ is calculated using either the signal/noise ratio, or using standard deviation of analytical signal and the slope of the calibration curve.

For the calculation using analytical signal/noise level ratio it is necessary to determine the minimum amount (concentration) of the analyte in the sample, in which the signal/noise ratio ≥ 10 ; in the second case LOQ is calculated from the equation:

$$LOD = 10 \times S/b,$$

where S – standard deviation of the analytical signal;
 b – coefficient of sensitivity, which is the ratio of the analytical signal to value to be determined, the slope of the calibration curve $y = b \times x + a$.

If there are experimental data in a wide range of the measured values, S and b can be estimated by least square method. Generally, if there is evidence that procedure is suitable for reliable detection of the analyte in the range of its concentrations both above and below the norm of its content established specification, the LOQ calculation is not required.

For LOQ determination the number of samples with a decreasing amount of analyte should be analyzed, then calibration graph RSD – concentration of the analyte (c) should be plotted (Fig. 2.2). According to the curve of the concentration, which corresponds to a predetermined intermediate precision (in this example, 33%).

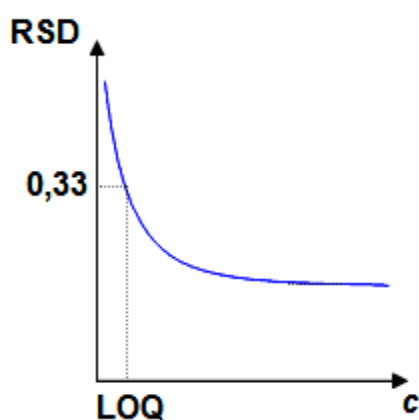

Fig. 2.2. Plot of the relative standard deviation (RSD) – analyte's concentration

For most procedures RSD is 5–10% and increases with decreasing concentration of the analyte in the sample (Fig. 2.3).

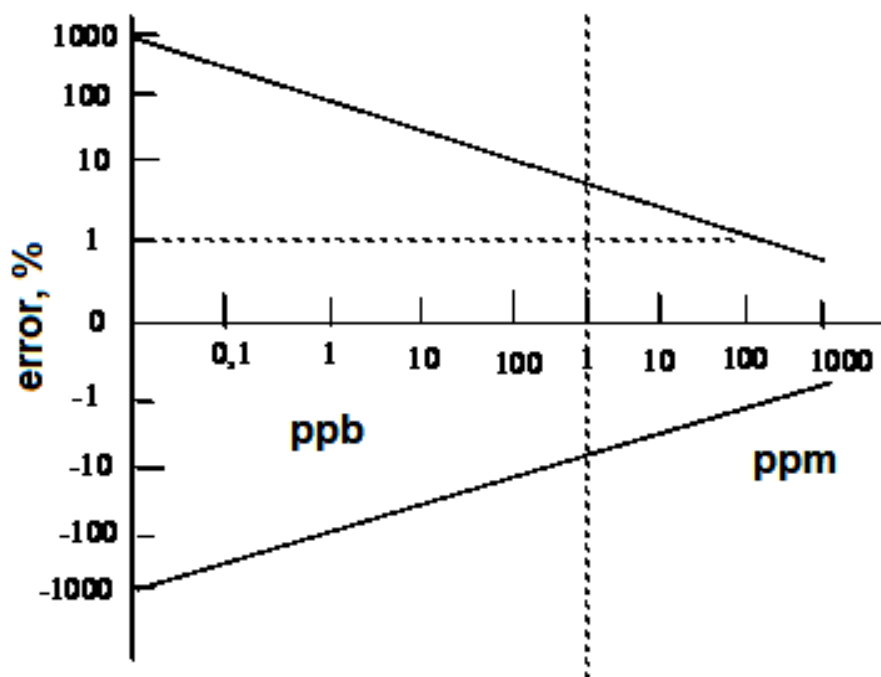

Fig. 2.3. Reliability changing for the trace analysis

Selectivity and Specificity. The proposal procedure is selective if it allows quantitative determination of the analyte in a mixture of compounds with similar properties without bias. If proposal procedure provides the ability to identify and determine quantitatively only one component, the procedure is specific.

For identification test the proposal procedure should provide reliable information on the presence of the drug in the API or dosage form in the presence of other recipe ingredients.

For quantitative tests (assays) procedure's specificity should be estimated, that is it should be proved experimentally that the presence of related substances does not effect on the result of analysis.

Evaluation of specificity is performed either by analysis of model mixtures containing the analyte and with known composition, or comparison of the results of analysis of real objects obtained by proposal analytical procedure with those of a second

well-characterized procedure, the specificity which is stated and/or defined.

The specificity is confirmed also by the analysis of blank samples without the analyte. For example Fig. 2.4 shows the chromatograms for the HPLC determination of drugs in blood serum. Chromatograms of the compared samples of blood plasma show that endogenous substances do not interfere with identification of the test components – drugs.

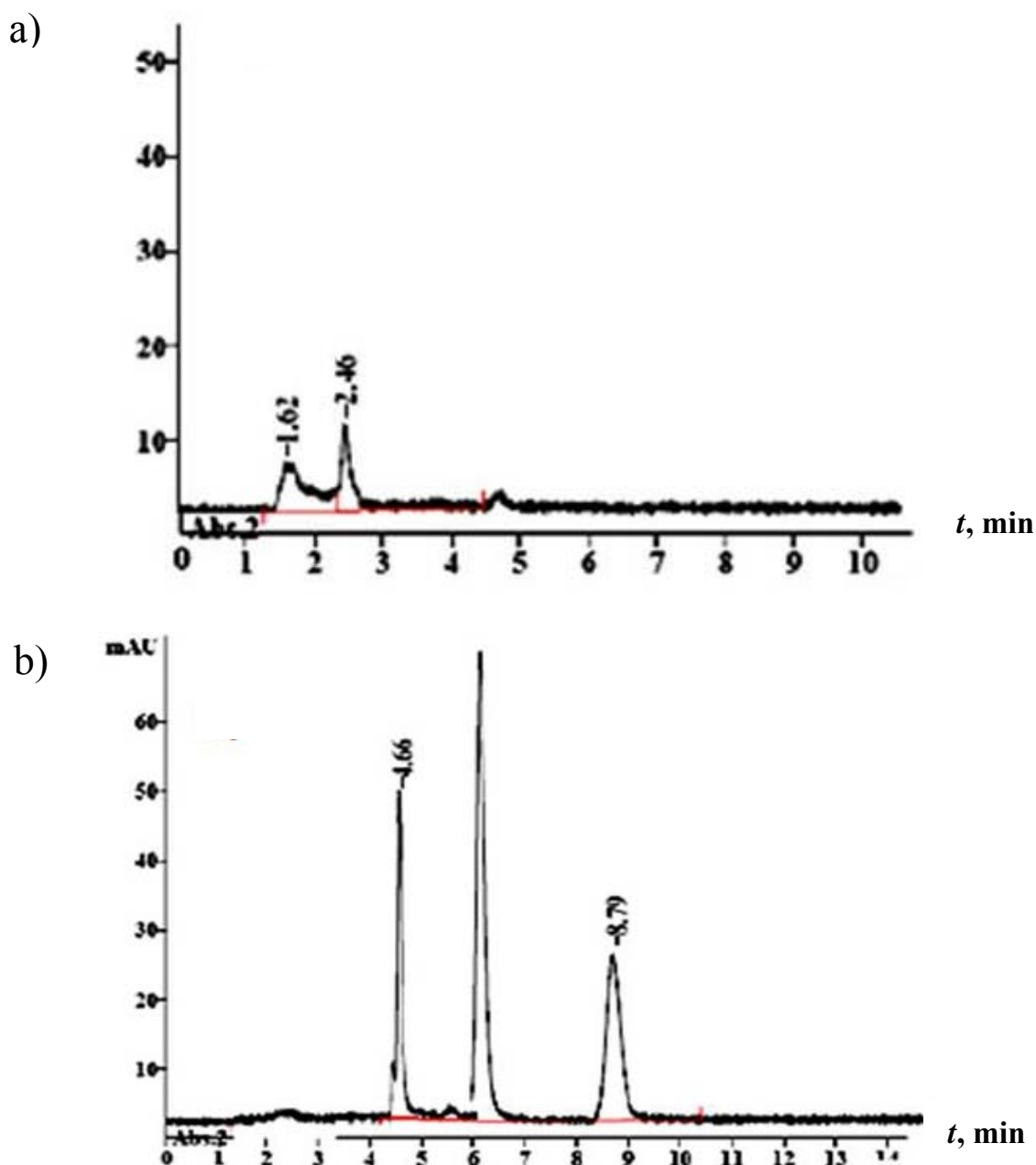

Fig. 2.4. HPLC chromatograms of blood serum samples:

- a) sample without the analytes (blank test);
- b) spiked sample (standard addition of analytes)

Robustness is the ability of validating procedures to remain unaffected by small but deliberate variations in method parameters. It means the procedure should save estimated characteristics illustrated in Table 1, obtained in optimal (nominal) conditions, with the likely small deviations from these conditions.

Robustness should not be defined in relation to an easily controlled conditions of the analysis. It reduces the need for a special study of the robustness. Robustness should be studied only in those cases when the proposal procedure is based on methods, sensitive to external conditions such as various types of chromatography and functional analysis. If necessary robustness assessment is performed during the development of procedure. If the procedure possesses probable low robustness, it is necessary to check suitability directly in practical use.

Linearity is the presence of a linear relationship between analytical signal and concentration (amount) of analyte in the sample within a given range of analytical procedure. Linearity of procedure to be validated is estimated experimentally by measuring the analytical signals for at least five samples with different amounts or (concentrations) of the analyte. The correlation coefficient (r) should be calculated. In analytical chemistry in most cases, use linear dependence, corresponding to $|r| \geq 0,99$, and only in the analysis of trace amounts linear relations, for which $|r| \geq 0,9$ are considered. It should be noted that the confidence intervals are within 2%, with the degree of reliability of 0,05, only if $|r| \geq 0,9995$.

Linearity can be represented graphically as a function analytical signal – analyte concentration (Fig. 2.5).

System Suitability Test is test of basic requirements implementing. System which suitability must be checked is a set of specific instruments, reagents, standards and test samples. This test provides assurances that the system is working properly at the time of analysis, ensures that both methodology and instrumentation are performing within expectations prior to the analysis of the test samples. System suitability should be monitored during run time to verify that the criteria remain realistic and achievable. Such system requirements are usually specified in the relevant pharmacopoeial general chapter on appropriate ana-

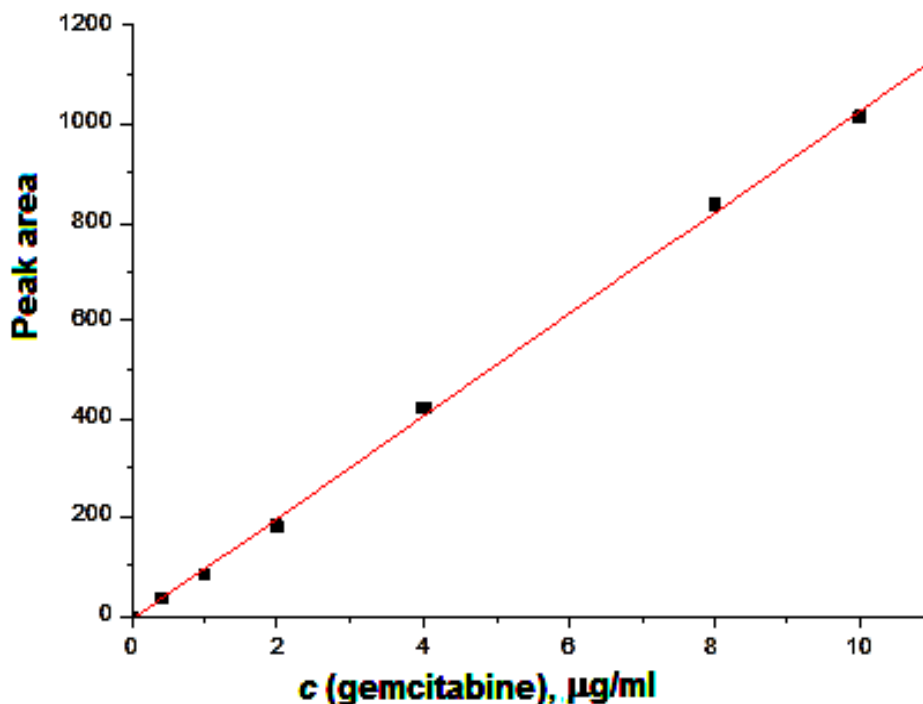

Fig. 2.5. Dependence of the area of chromatographic peaks of the concentration of the active ingredient (gemcitabine) in the «Gemzar»

lytical method. Thus, analytical system suitability test should be included in validating procedure.

For example, the results of HPLC procedure are considered to be reliable, if the chromatographic system meets the following requirements:

- the relative retention times of relevant substances should be near specified values;
- the number of theoretical plates (efficiency of chromatographic system) calculated at the relevant peak, should not be less than the specified value;
- chromatographic peaks resolution should be not less the specified value;
- RSD, calculated for the height or area of relevant peak, or their relationship to the height or area of the internal standard from the chromatogram of Standard preparation should be less than the specified value;
- tailing factor of relevant peak, calculated from the chromatogram of Reference Standard preparation should be within the limits given in the specified pharmacopoeial monograph.

– statistical treatment of data, obtained experimentally during the development or verification of analytical procedure, system suitability tests results;

– illustrative materials, such as copies of HPLC or GC chromatograms, copies of UV-, IR-spectra, photographs or drawings of the TLC- or paper-chromatograms, pictures of the titration curves;

– general conclusion about the analytical procedure's suitability for inclusion in the normative documents (pharmacopoeial monograph, etc.).

Validation materials of separate analytical procedures to be included in the normative document draft is recommended to present as a joint validation report.

MODULE 2
PHYSICAL ANALYSIS
FOR MEDICINES QUALITY CONTROL

Topic 3

Thermal analysis in leading pharmacopoeias.
Melting point determination of API

Objective: to study pharmacopoeial methods of thermal analysis used for the quality control of API and drugs.

Thermal processes such as chemical reactions, phase transition or loss of crystallization water are always accompanied by more or less significant changes of enthalpy (ΔH). The conversion can result in either the absorption of heat – an endothermic process, or heat release – exothermic process. These thermal effects are detected by means of thermal analysis.

Thermal analysis is the general name of techniques for investigating physicochemical and chemical processes, based on detection the thermal effects that accompany the transformation of a substance under temperature programming conditions. Temperature change can be achieved by heating or cooling at a specified speed, or a combination of different modes. A characteristic feature of thermal analytical methods is their versatility.

Instrumental methods of thermal analysis provide information about the crystal structure, boiling or melting points, the capacity for sublimation, dehydration, the solid-phase interaction.

This information can be applied for identification; impurities limit tests, water content and stability of API, assay of thermally unstable substances, various polymorphic forms detection, compatibility of API and excipients in drug product, selection of packaging and quality control methods.

Depending on the recorded parameters (property to measure) there are the following methods of thermal analysis Table 3.1.

Table 3.1

Methods of thermal analysis

Method	Measured parameter
Thermogravimetric analysis (TGA)	Mass
Differential Thermal Analysis (DTA)	Temperature difference between the sample under investigation and reference material
Differential Scanning Calorimetry (DSC)	Difference in the flow of heat evolved or absorbed by the test sample compared with the reference cell, as a function of the temperature
Thermo mechanical analysis	Deformations
Thermo optical analysis	Optical properties
Dilatometry (DIL)	Volume
Dielectric Thermal analysis	Dielectric capacitivy
Gas Analysis	Gas phase composition

The easiest way to capture the results of thermal analysis is visual observation. It involves the observation and temperature measurement of the first appearance (disappearance) of heterogeneous substance (such as the formation of crystals, melting material) in the investigated medium at cooling or heating.

Method of construction of thermo-analytical curves in coordinates «measured physical parameter – time/temperature» is more informative. Schematic diagram of the thermoanalytical device is shown in Fig. 3.1. It is used in almost all thermal analysis techniques.

In most cases, the sample is inside the container or crucible, which is in contact with the sensor that measures the relevant property. In this case, the sensor records the temperature during the entire process in the vicinity of the sample.

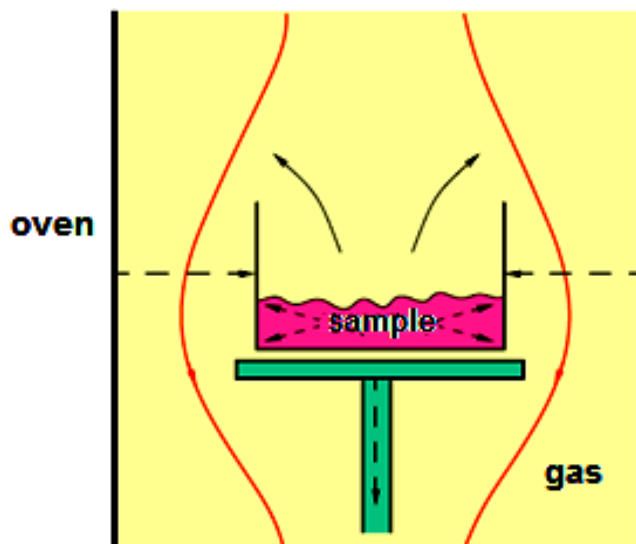

Fig. 3.1. Thermoanalytical cell

Sensor system with the sample (cell) is inside the furnace in an oven environment. Operation of the oven is performed by temperature programmer, and, depending on the experimental requirements temperature in the oven can be increased, reduced or kept constant.

The dependence between measured properties and temperature is displayed as *thermoanalytical curve* on the computer screen. Common thermal analysis has low sensitivity. At a low specific heat effect per unit mass or where little amount of phase to turn, inflections on thermal curves are barely visible, therefore, the transformation cannot be detected.

Differential methods are more sensitive, because heating (cooling) of the sample is performed together and in the same conditions with reference standard material, which is in sustainable (inert). In this case, the curves «time – property» and «time – the difference between the properties» for the sample and reference material are recorded at the same graph. This difference appears with any conversion of the sample flowing with absorption (release) of heat. The nature of the transformation is judged by the form of the heating (cooling) curve, while the temperature of transformation is accurately determined from the differential curve.

In pharmacopeial thermal analysis (general chapter «Thermal analysis» – Ph. Eur., JP, USP) three methods are used: Dif-

ferential thermal analysis (DTA), Differential Scanning Calorimetry (DSC) and Thermal Gravimetric Analysis (TGA).

In **Differential Thermal Analysis (DTA)** the *temperature difference* between the sample under investigation and an inert reference material is measured as a function of temperature. Both samples are treated with the same temperature program and the same heating and cooling rates.

The difference of the temperatures is registered parameter, measured by heating or cooling the sample at a constant rate, which can be represented as a function of the temperature of the sample, standard material or heater. Temperature changes of the sample caused by the phase transitions or chemical reactions associated with the change of enthalpy. These are: phase transitions – melting, alteration of the crystal structure, boiling, sublimation and evaporation, chemical reactions – dehydration, dissociation, decomposition, oxidation, reduction, etc. These transformations are accompanied by the absorption or release of heat. In general, phase transitions, dehydration, reduction, and some decomposition reactions are accompanied by endothermic effects, crystallization, oxidation and some degradation processes – exothermic.

Possible determination of even small differences in temperature between the sample and the standard make for the high sensitivity of the DTA and allows to study little mass of sample (up to several milligrams). A typical DTA curve with four types of transitions is shown in Fig. 3.2.

The number, shape and position of the various exo- and endothermic peaks with respect to the temperature scale is the identification of a substance. Since the area of the peak is proportional to the change in enthalpy ΔH , DTA method can be used for semi-quantitative, and in some cases for quantitative evaluation of the heat of reaction.

Differential Scanning Calorimetry (DSC) is a method of thermal analysis, in which the difference between the rate of heat flow in the sample and the rate of heat flow in the standard (reference material) is recorded as a function of temperature and/or time when they are exposed to the same temperature program in

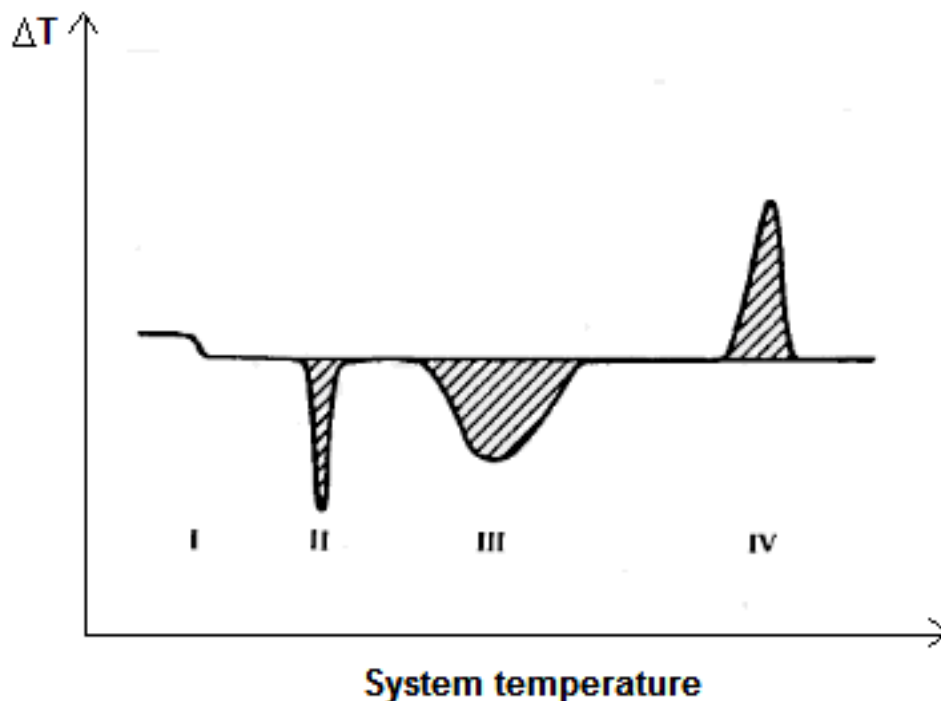

Fig. 3.2. A typical DTA curve:

- I – shift the baseline;
- II – endothermic shift due to melting;
- III – endothermic peak caused by the decomposition reaction or dissociation;
- IV – exothermic peak due to the phase change in the crystal

one and the same environment when using symmetric (double) measuring system. Strictly speaking, difference in the flow of heat in the crucible with the sample and the empty crucible or crucible containing the reference. DSC curve is very similar to the DTA curve, except adopted units on the vertical axis.

DTA and DSC methods allow us to study the changes in the drug during polymorphic transformations at different heating rates. Thus, for example, one can determine the heating rate, which is necessary to ensure a polymorphic purity of the product (it is sometimes necessary to provide the rate up to 750 °C/min).

In addition, using the DTA and DSC methods we can determine such pharmacopoeial quality level of drugs as the melting point, freezing point, boiling point, etc.

Thermal gravimetric analysis (TGA) is a technique in which the mass of a sample of a substance is recorded as a function of temperature according to a controlled temperature programme.

There are three types of thermogravimetry:

a) *isothermal* or static, when the mass of the sample is measured over time at a constant temperature;

b) *quasi-static*, when the sample is heated at each of a series of increasing temperature until constant weight values;

c) *dynamic*, when the temperature of the environment surrounding the heated sample, varies in a given law (usually a constant rate).

The curve of the changes in mass of the temperature (thermolysis curve thermogram, etc.) experimentally obtained gives an indication of the thermal stability and composition of the sample in the initial state of the thermal stability and composition of the substances formed in the intermediate stages of the process and the composition of the residue, if it forms (see Fig. 3.3).

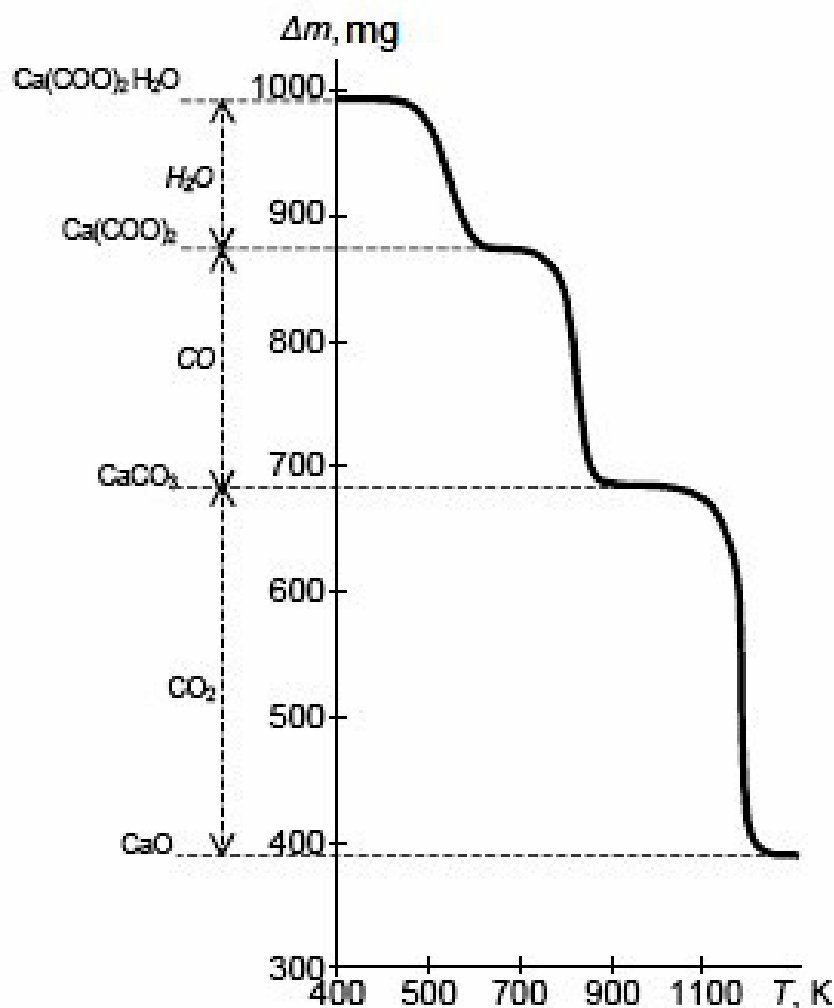

Fig. 3.3. Thermogram of decomposition of calcium oxalate monohydrate $CaC_2O_4 \cdot H_2O$

TGA method is effective only if the sample emit volatile substances as a result of various physical and chemical processes. In pharmacopeial analysis TGA method is used to determine the water content, loss on drying, loss on ignition and residue on Ignition test.

Topic 4

Optical methods for medicines quality control. Polarimetry

Objective: to create a system of knowledge about the optical pharmacopoeial methods of medicines quality control on the example of polarimetry.

Optical isomers, or enantiomers, have the same sequence of atoms and bonds but are different in their 3D shape. Two enantiomers are nonsuperimposable mirror images of one another (i.e., chiral), with the most common cited example being our hands (Fig. 4.1).

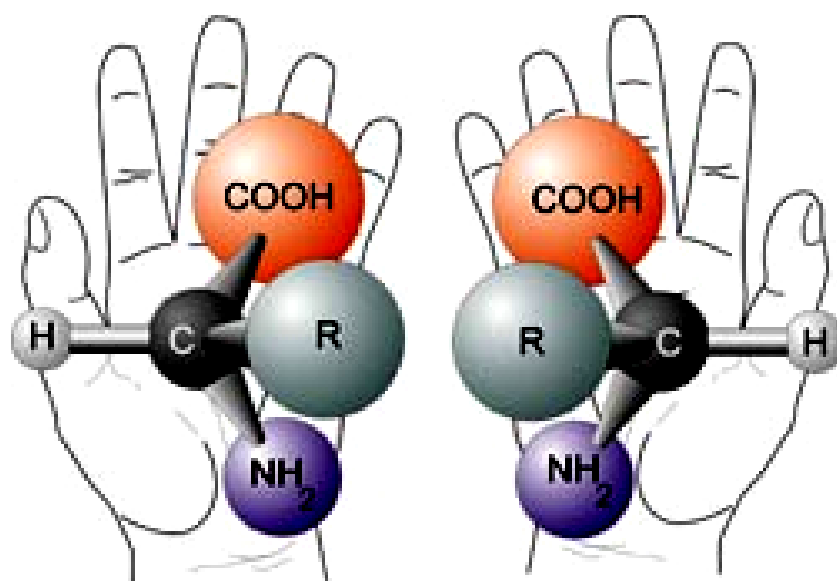

Fig. 4.1. Amino acids are the example of chiral molecules

Our left hand is a mirror image of our right, yet there is no way our left thumb can be over our right thumb if our palms are facing the same way and placed over one another. Optical isomers also have no axis of symmetry, which means that there is no line that bisects the compound such that the left half is a mirror image of the right half.

Optical isomers have basically the same properties (melting points, boiling points, etc.) but there are a few exceptions (uses in biological mechanisms and optical activity). There are drugs, called enantiopure drugs, that have different effects based on whether the drug is a racemic mixture or purely one enantiomer. For example, d-ethambutol treats tuberculosis, while l-ethambutol causes blindness. Optical activity is the interaction of these enantiomers with plane-polarized light.

Optical isomers differ in a property called optical activity, in which a sample rotates the plane of polarization of a polarized light beam passing through. This effect was first discovered in 1808 by E.L. Malus, who passed light through reflective glass surfaces. Four years later, J.B. Biot found that the extent of rotation of the light depends on the thickness of the quartz plates that he used. He also discovered that other compounds i.e., sucrose solutions were capable to rotate the light. He attributed this «optical activity» to the certain features in their molecular structure (asymmetry). Because of his research, he designed one of the first polariscopes, and formulated the basic quantitative laws of polarimetry.

In 1849, Louis Pasteur resolved a problem concerning the nature of tartaric acid (Fig. 4.2).

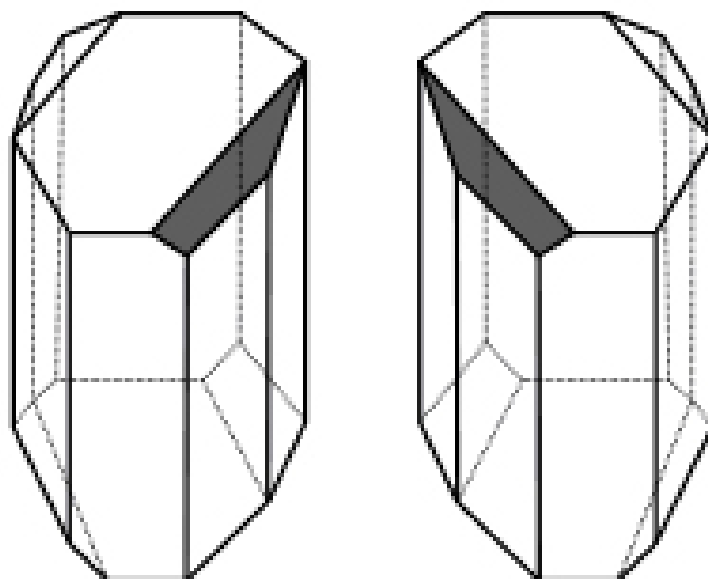

Fig. 4.2. Enantiomorphous crystals of the dextrorotatory and levorotatory tartrates

A solution of this compound derived from living things (to be specific, wine lees) rotates the plane of polarization of light passing through it, but tartaric acid derived by chemical synthesis has no such effect, even though its reactions are identical and its elemental composition is the same. Pasteur noticed that the crystals come in two asymmetric forms that are mirror images of one another. Sorting the crystals by hand gave two forms of the compound: Solutions of one form rotate polarized light clockwise, while the other form rotates light counterclockwise. An equal mix of the two has no polarizing effect on light. Pasteur deduced that the molecule in question is asymmetric and could exist in two different forms that resemble one another as would left- and right-hand gloves, and that the organic form of the compound consists of purely the one type.

In 1850, Wilhelmy used polarimetry to study the reaction rate of the hydrolysis of sucrose. In 1874, van't Hoff proposed that a tetrahedral environment of the carbon atom could explain the phenomenon of optical activity. Today, polarimetry is used routinely in quality and process control in the pharmaceutical industry, flavor, fragrance and essential oil industry, food industry, and chemical industry. The optical purity of the product can be determined by measuring the specific rotation of different compounds and comparing them with the reference value (if the specific rotation of the pure enantiomer is known).

Polarimetry is the measurement and interpretation of the polarization of electromagnetic waves that have traveled through some material in order to characterize that object. Polarimetry is a sensitive, nondestructive technique for measuring the optical activity exhibited by inorganic and organic compounds. Some chemical substances are optically active, and polarized (unidirectional) light will rotate either to the left (counter-clockwise) or right (clockwise) when passed through these substances. The amount by which the light is rotated is known as the angle of rotation. A polarimeter is a scientific instrument used to measure the angle of rotation caused by passing polarized light through an optically active substance (Fig. 4.3).



Fig. 4.3. An automatic digital polarimeter

Construction of polarimeter. The polarimeter is made up of two Nicol prisms (the polarizer and analyzer). The polarizer is fixed and the analyzer can be rotated. The prisms may be compared to as slits S1 and S2. The light waves may be considered to correspond to waves in the string. The polarizer S1 allows only those light waves which move in a single plane. This causes the light to become plane polarized. When the analyzer is also placed in a similar position it allows the light waves coming from the polarizer to pass through it. When it is rotated through the right angle no waves can pass through the right angle and the field appears to be dark. If now a glass tube containing an optically active solution is placed between the polarizer and analyzer the light now rotates through the plane of polarization through a certain angle, the analyzer will have to be rotated in same angle.

Measuring optical rotation. The sample is usually prepared as a tube where the optically active substance is dissolved in an optically inactive chemical such as distilled water, ethanol, methanol. Optically active samples, such as solutions of chiral molecules, causes rotation of the polarization of plane polarized light as it passes through the sample (Fig. 4.4).

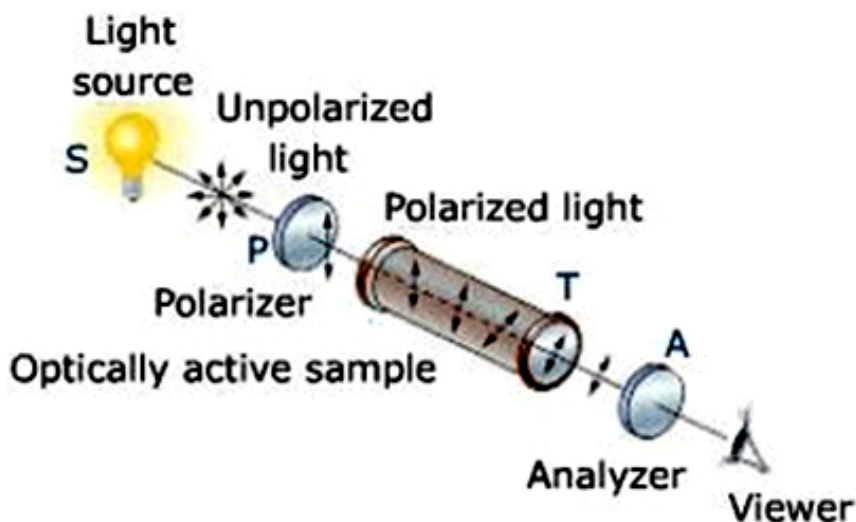

Fig. 4.4. Circuit to explain the rotation of polarized light plane as it passes through the optically active sample

In an ordinary light, the vibrations occur in all planes perpendicular to direction of propagation. When it is allowed to pass through a Nicol prism then its vibrations in all directions except the direction of axis of the prism are cut off. The light emerging out of the prism is said to be plane polarised because its vibration is in one direction. If two Nicol prisms are placed with their polarization planes parallel to each other, then the light rays emerging out of the first prism will enter the second prism. As a result complete bright light is observed. If the second prism is rotated by an angle of 90° , the light emerging from the first prism is stopped by the second prism due to which complete dark or no light region is observed.

In a polarimeter (Fig. 4.4), plane-polarized light is introduced to a tube (typically 10 cm in length) containing a solution with the substance to be measured. If the substance is optical inactive, the plane of the polarized light will not change in orientation and the observer will read an angle of $\alpha = 0^\circ$. If the compound in the polarimetry cell was optical active, the plane of the light would be rotated on its way through the tube. The observed rotation is a result of the different components of the plane polarized light interacting differently with the chiral center. In order to observe the maximum brightness, the observer

(person or instrument) will have to rotate the axis of the analyzer back, either clockwise or counterclockwise direction depending on the nature of the compound. For clockwise direction, the rotation (in degrees) is defined as positive («+») and called dextrorotatory (from the Latin: dexter = right). In contrast, the counterclockwise direction is defined as negative («-») and called levorotatory (from the Latin laevus=left).

Unfortunately, there is no direct correlation between the configuration [(D/L) in Fischer-Rosanoff, (R/S) in Cahn-Ingold-Prelog nomenclature] of an enantiomer and the direction [(+) or (-)] in which they rotate plane-polarized light. This means that the R-enantiomer can exhibit a positive or negative value for the optical rotation depending on the compound. In some cases, the solvent has an impact on the magnitude and the sign as well i.e., (S)-lactic acid exhibits an optical rotation of $[\alpha] = +3,9^\circ$ in water and $[\alpha] = +13,7^\circ$ using 2M sodium hydroxide solution as solvent because the observer looks at a different species (lactate).

A simple polarimeter to measure this rotation consists of a long tube with flat glass ends, into which the sample is placed. At each end of the tube is a Nicol prism or other polarizer. Light is shone through the tube, and the prism at the other end, attached to an eye-piece, is rotated to measure the region of complete brightness or half-dark half-bright region or complete dark region. The angle of rotation is then read from a scale. The same phenomenon is observed after an angle of 180° . The analyzer rotates either via manual rotation or automatic detection of the angle. When the analyzer is rotated to the proper angle, the maximum amount of light will pass through and shine onto a detector.

The specific rotation of the sample may then be calculated. Temperature can affect the rotation of light, which should be accounted for in the calculations.

$$[\alpha]_{\lambda}^T = \frac{\alpha}{l \times c},$$

where $[\alpha]_{\lambda}^T$ is the specific rotation in degrees $\text{cm}^3 \text{ dm}^{-1} \text{ g}^{-1}$;
 T – the temperature in degrees;

λ – the wavelength of light in nanometers;
 α – the optical rotation (the angle of rotation);
 l – the length of the polarimeter tube (optical path length in decimeters);
 c – the mass concentration of solution (g/ml).

Historically, polarimetry was performed using an instrument where the extent of optical rotation is estimated by visual matching of the intensity of split fields. For this reason, the D-line of the sodium lamp at the visible wavelength of 589 nm was most often employed. Use of lower wavelengths, such as those available with the mercury lamp lines isolated by means of filters of maximum transmittance at approximately 578, 546, 436, 405, and 365 nm in a photoelectric polarimeter, have been found to provide advantages in sensitivity with a consequent reduction in the concentration of the test compound. In general, the observed optical rotation at 436 nm is about double and at 365 nm about three times that at 589 nm. Reduction in the concentration of the solute required for measurement may sometimes be accomplished by conversion of the substance under test to one that has a significantly higher optical rotation. Optical rotation is also affected by the solvent used for the measurement, and this is always specified.

Most manual polarimeters produced today are applied to the original optomechanical design over the years have significantly improved measurement performance. They incorporate a long-life yellow LED in place of the more traditional and costly sodium arc lamp.

Today there are also semi-automatic polarimeters, which require visual detection but use push-buttons to rotate the analyzer and offer digital displays.

The most modern polarimeters are fully automatic, and simply require the user to press a button and wait for a digital readout. Fast automatic digital polarimeters reduce measuring time to just one second, regardless of the rotation angle of the sample. In addition, they permit continuous measurement, for example for kinetic investigations or in HPLC. Special tech-

niques like a temperature controlled sample tube reduce measuring faults and ease operation. Results can directly be transferred to computers or networks for automatic processing.

Sources of error. The angle of rotation of an optically active substance can be affected by: concentration of the sample; wavelength of light passing through the sample (generally, angle of rotation and wavelength tend to be inversely proportional); temperature of the sample (generally the two are directly proportional); length of the sample cell (input by the user into most automatic polarimeters to ensure better accuracy). Most modern polarimeters have methods of compensating for or controlling these errors.

The polarimeter must be capable of giving readings to the nearest $0,01^\circ$. The scale is usually checked by means of certified quartz plates. The linearity of the scale may be checked by means of sucrose solutions (USP<781>).

Calibration. Polarimeters can be calibrated – or at least verified – by measuring a quartz plate, which is constructed to always read at a certain angle of rotation (usually $+34^\circ$, but $+17^\circ$ and $+8,5^\circ$ are also popular depending on the sample). Quartz plates are preferred by many users because solid samples are much less affected by variations in temperature, and do not need to be mixed on-demand like sucrose solutions.

Applications. Because many optically active chemicals such as sucrose, are stereoisomers, a polarimeter can be used to identify which isomer is present in a sample – if it rotates polarized light to the left, it is a levo-isomer, and to the right, a dextro-isomer. It can also be used to measure the ratio of enantiomers in solutions.

Many chemicals exhibit a specific rotation as a unique property (like refractive index in many cases) which can be used to distinguish it. Polarimeters can identify unknown samples based on this if other variables such as concentration and length of sample cell length are controlled or at least known. It is being developed as a method to measure blood sugar concentration in diabetic people.

The polarimetric method is a simple and accurate means for determination and investigation of structure in macro, semi-micro and micro analysis of expensive and non-duplicable samples. Polarimetry is employed in quality control, process control and research in the pharmaceutical, chemical, essential oil, flavor and food industries. It is so well established that the United States Pharmacopoeia and the Food & Drug Administration, European Pharmacopoeia, Japan Pharmacopoeia include polarimetric specifications for numerous substances.

Research applications for polarimetry are found in industry, research institutes and universities as a means of:

- isolating and identifying unknowns crystallized from various solvents or separated by high performance liquid chromatography (HPLC);
- evaluating and characterizing optically active compounds by measuring their specific rotation and comparing this value with the theoretical values found in literature;
- investigating kinetic reactions by measuring optical rotation as a function of time;
- monitoring changes in concentration of an optically active component in a reaction mixture, as in enzymatic cleavage;
- analyzing molecular structure by plotting optical rotatory dispersion curves over a wide range of wavelengths;
- distinguishing between optical isomers.

By the same token, if the specific rotation of a sample is already known, then the concentration and/or purity of a solution containing it can be calculated. Most automatic polarimeters make this calculation automatically, given input on variables from the user. Concentration and purity measurements are especially important to determine product or ingredient quality in the food & beverage and pharmaceutical industries. Samples that display specific rotations that can be calculated for purity with a polarimeter include: steroids, diuretics, antibiotics, narcotics, vitamins, analgesics, amino acids, essential oils, polymers, starches, sugars.

Polarimeters are used in the sugar industry for determining quality of both juice from sugar cane and the refined sucrose. Often, the sugar refineries use a modified polarimeter with a flow cell called a saccharimeter. Saccharimeters are also used in pharmacy.

Practical Aspects. The cell has to be handled carefully since it costs more than \$1000 to manufacture. It has to be cleaned thoroughly after the measurement was performed and is returned to the teaching assistant or instructor. Special attention should be given to the inlets that have been broken off several times already due to negligence on the student's part!

1. The instrument has to warm up for at least 10–15 minutes, if it is not already turned on. The switch is located in the back of the instrument. The proper wavelength is chosen.

2. A solution with a known concentration ($\sim 0,5\text{--}3\%$) of the compound in the proper solvent is prepared.

3. The polarimetry cell is filled with the solvent. After filling the cell, the path through the cell should be clear (If the path is not clear, the air bubbles in the path have to be removed prior to the measurement). The cell is placed on the rails inside the instrument, all the way on either the right or the left side.

4. The «Zero button» is pressed to zero the instrument. The screen should show 0,000 and not fluctuate too much. If this is not the case, make sure that the light can pass through. If this does not solve the problem, inform the teaching assistant or instructor about this problem immediately.

5. Then, the solvent is removed and the cell is dried. The solution of the compound is filled into the dry polarimeter cell making sure that the entire inner part is filled without any air bubbles or particulate matter.

6. The «I» button on the keypad is pressed and specific rotation is selected.

7. The proper cell dimension is selected: 100 mm (the cell provided is 100,0 mm = 1 dm long).

8. Next, the proper concentration in% is entered (= the actual concentration of your solution and not the one recommended since they will most likely differ slightly!).

9. The reading on the display (= specific optical rotation) is recorded including the sign. (The experimenter has to research the literature data before performing the measurement in order to see if he is in the correct ballpark!).

10. The cell is taken out, cleaned thoroughly with the solvent used for the measurement and returned it to your teaching assistant or instructor. If the student is the last one to perform a measurement for the day, the instrument has to be turned off as well.

11. The sample from the optical rotation measurement can be recovered after the measurement if needed by removing the solvent i.e., Jacobsen ligand.

Topic 5

Optical methods for medicines quality control. Refractometry

Objective: to create a system of knowledge about the optical pharmacopoeial methods of medicines quality control on the example of refractometry.

Refraction of light is the bending of light rays at the interface of dissimilar substances. When light is passing from a lower refractive substance into a higher refractive substance the light rays bend toward the perpendicular to the surface. When light is passing from a higher (Fig. 5.1).

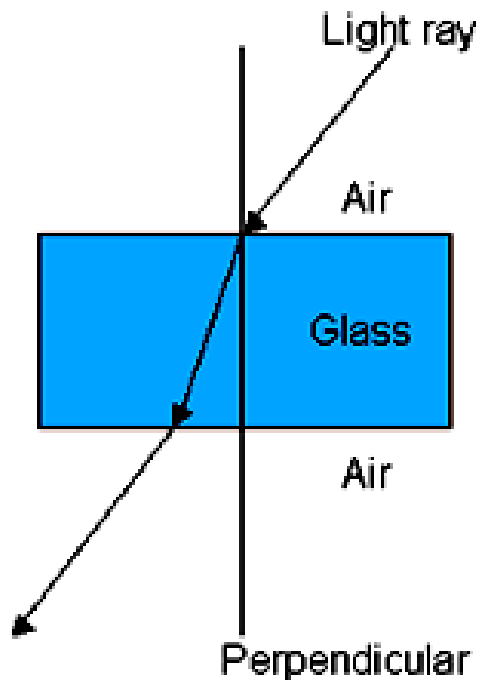

Fig. 5.1. Angle of refraction

Refraction can be easily demonstrated by placing a spoon, fork, knife, or straw in a glass of water (Fig. 5.2). As the light passes from the air into the water it is bent and the utensil appears bent.

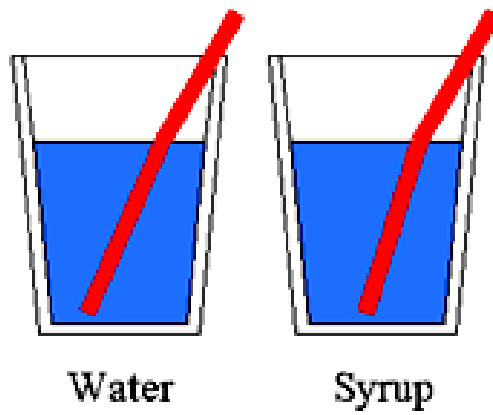

Fig. 5.2. **Demonstration of refraction**

To see the increased refraction with an increase in solution density, note the greater apparent bend of the utensil in corn syrup. It should be noted that in these examples the light actually passes from air through glass through water through glass again then exits to air. The reverse passages through the glass cancel each other out and the apparent bend in the utensil is overwhelmingly due to the difference in refractive index of air and water.

Refractive index. In optics the refractive index or index of refraction n of a substance (optical medium) is a dimensionless number that describes how light, or any other radiation, propagates through that medium. It is defined as

$$n = \frac{c}{v},$$

where c is the speed of light in vacuum and v is the phase velocity in the substance.

For example, the refractive index of water is 1,33, meaning that light travels 1,33 times as fast in vacuum as it does in water (Table 5.1).

The historically first occurrence of the refractive index was in *Snell's law of refraction*:

$$n_1 \cdot \sin\theta_1 = n_2 \cdot \sin\theta_2,$$

where θ_1 and θ_2 are the angles of incidence of a ray crossing the interface between two media with refractive indices n_1 and n_2 (Fig. 5.3).

Table 5.1

Selected refractive indices at $\lambda = 589 \text{ nm}$

Material	N
Gases at 0 °C and 1 atm	
Air	1,000293
Helium	1,000036
Hydrogen	1,000132
Carbondioxide	1,00045
Liquids at 20 °C	
Water	1,333
Ethanol	1,36
Benzene	1,501
Solids	
Ice	1,309
Fusedsilica	1,46
PMMA (Plexiglas)	1,49
Crown-glass (typical)	1,52
Flint-glass (typical)	1,62
Diamond	2,42

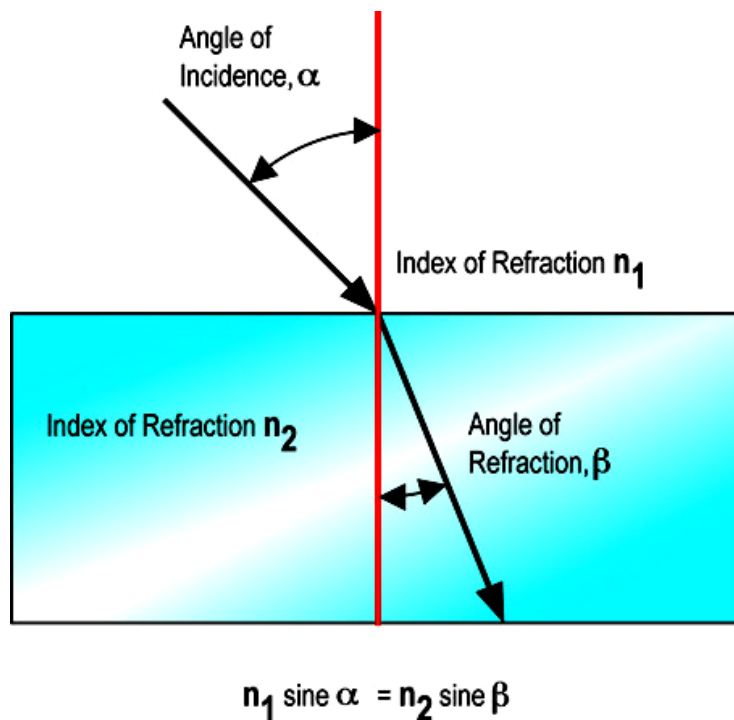

Fig. 5.3. Graphical representation of the refractive index

Brewster's angle, the critical angle for total internal reflection, and the reflectivity of a surface also depend on the refractive index, as described by the Fresnel equations (Fig. 5.4).

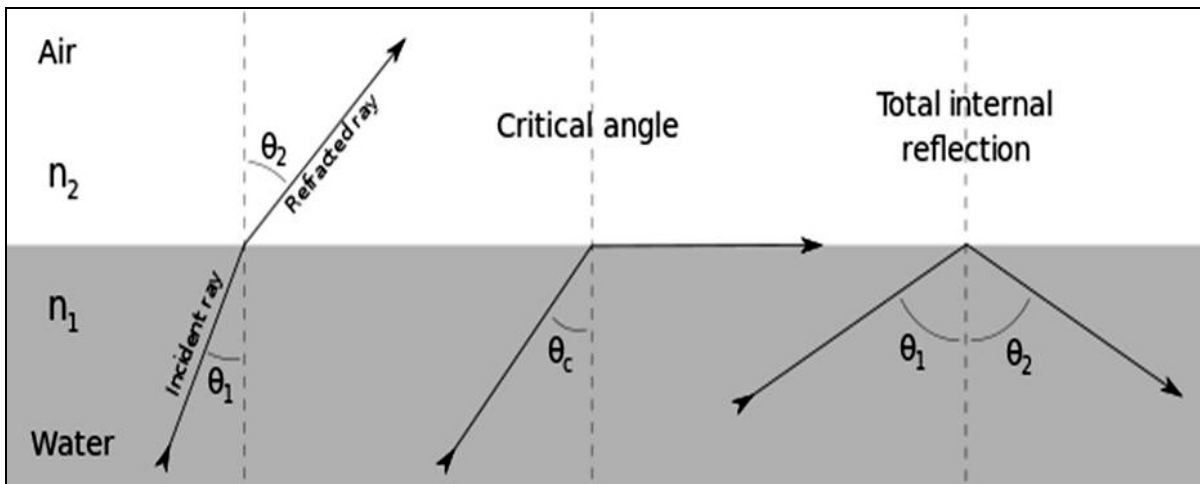

Fig. 5.4. **Refraction, critical angle and reflection of light at the interface between two media**

For visible light most transparent media have refractive indices between 1 and 2. A few examples are given in the table to the right. These values are measured at the yellow doublet sodium D-line, with a wavelength of 589 nanometers, as is conventionally done. Gases at atmospheric pressure have refractive indices close to 1 because of their low density. Almost all solids and liquids have refractive indices above 1,3, with aerogel as the clear exception. Aerogel is a very low density solid that can be produced with refractive index in the range from 1,002 to 1,265. Diamond lies at the other end of the range with a refractive index as high as 2,42. Most plastics have refractive indices in the range from 1,3 to 1,7, but some high-refractive-index polymers can have a value as high as 1,76.

For infrared light refractive indices can be considerably higher. Germanium is transparent in this region and has a refractive index of about 4, making it an important material for infrared optics.

Refractometer. Refractometers are instruments that measure the bending of light as it crosses an interface between dissimilar substances and converts the bending light rays into a

useful scale. A refractometer is a laboratory or field device for the measurement of an index of refraction.

The principle of refractometers are presented in Fig. 5.5.

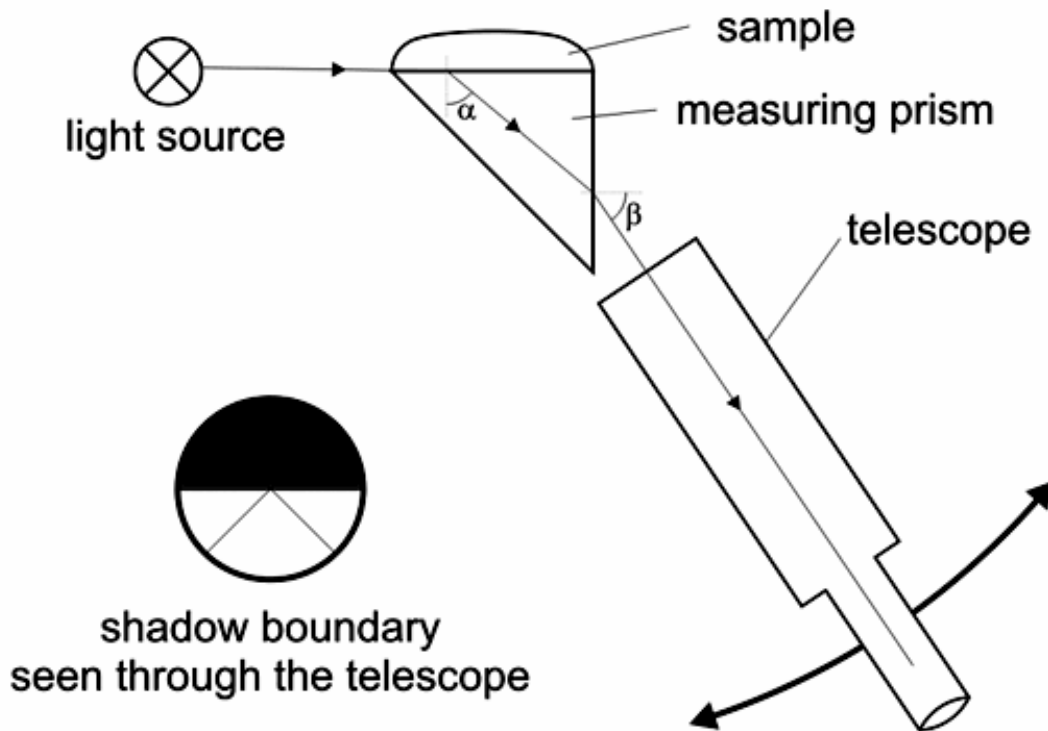

Fig. 5.5. The principle of refractometers

A thin layer of the liquid to be measured is placed between two prisms. Light is shone through the liquid at incidence angles all the way up to 90° , i.e., light rays parallel to the surface. The second prism should have an index of refraction higher than that of the liquid, so that light only enters the prism at angles smaller than the critical angle for total reflection. This point of view can then be measured either by looking through a telescope, or with a digital photo detector placed in the focal plane of a lens. The refractive index n of the liquid can then be calculated from the maximum transmission angle θ as $n = n_G \sin \theta$, where n is the refractive index of the prism.

It must be remembered that refractometers measure the refraction of light relative to some standard and some substance. For instance a refractometer calibrated to measure the salinity of water can be used to measure a sugar solution, but such a measurement is not accurate for sugar (Fig. 5.6).

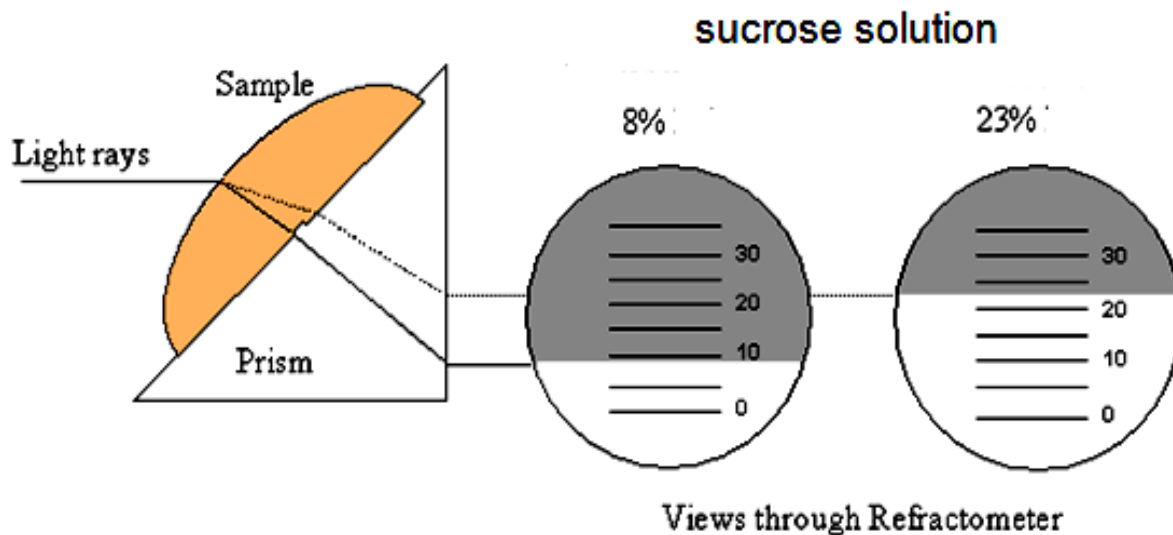

Fig. 5.6. **The need for calibration of refractometer**

In medicine, a refractometer is used to measure the total plasma protein in a blood sample and urine specific gravity. In drug diagnostics, a refractometer is used to measure the specific gravity in human urine.

Refractometers are often used in pharmaceutical applications for quality control of raw intermediate and final products. The manufacturers of pharmaceuticals have to follow several international regulations like FDA 21 CFR Part 11, GMP, Gamp 5, USP<1058>, which require a lot of documentation work. The manufacturers of automatic refractometers support these users providing instrument software fulfills the requirements of 21 CFR Part 11, with user levels, electronic signature and audit trail.

Furthermore, Pharma Validation and Qualification Packages are available containing:

- Qualification Plan (QP);
- Design Qualification (DQ);
- Risk Analysis;
- Installation Qualification (IQ);
- Operational Qualification (OQ);
- Check List 21 CFR Part 11 / SOP;
- Performance Qualification (PQ).

Refractometer users in pharmaceutical research, toxicology testing, compounding, and drug monitoring may require instru-

ments with reliable temperature control, compliance tracking, and specific measurement ranges. For example, refractometers can be used for total parenteral nutrition (TPN) control, toxicology testing (Urine SG), pharmacy compounding and drug diversion.

Enflurane, Sevoflurane and similar halogenated ethers are used extensively for the induction and maintenance of general anesthesia. Their manufacture must comply with specifications from the USP/EP or relevant pharmacopeias. Many of these pharmacopeias require the measurement of refractive index. For example, the US Pharmacopeia requires that sevoflurane has a refractive index of 1,2745–1,2760 at 20 °C.

There are four main types of refractometers: traditional handheld refractometers, digital handheld refractometers, laboratory or Abbe refractometers, and inline process refractometers. There is also the Rayleigh Refractometer used (typically) for measuring the refractive indices of gases.

Automatic refractometers are microprocessor-controlled electronic devices (Fig. 5.7). This means they can have a high degree of automation and also be combined with other measuring devices.



Fig. 5.7. Modern Automatic Refractometers

Flow cell with filling funnel for an automatic refractometer assures fast sample exchange, e.g. in quality control (Fig. 5.8).



Fig. 5.8. **Refractometer with funnel type sampler**

Flow cells. There are different types of sample cells available, ranging from a flow cell for a few microliters to sample cells with a filling funnel for fast sample exchange without cleaning the measuring prism in between. The sample cells can also be used for the measurement of poisonous and toxic samples with minimum exposure to the sample. Micro cells require only a few microliters volume, assure good recovery of expensive samples and prevent evaporation of volatile samples or solvents.

Once an automatic refractometer is equipped with a flow cell, the sample can either be filled by means of a syringe or by using a peristaltic pump. Modern refractometers have the option of a built-in peristaltic pump. This is controlled via the instrument's software menu. A peristaltic pump opens the way to monitor batch processes in the laboratory or perform multiple measurements on one sample without any user interaction. This eliminates human error and assures a high sample throughput.

If an automated measurement of a large number of samples is required, modern automatic refractometers can be combined with an automatic sample changer (Fig. 5.9).



Fig. 5.9. **Refractometer for multiparameter measurements**

The sample changer is controlled by the refractometer and assures fully automated measurements of the samples placed in the vials of the sample changer for measurements.

Today's laboratories do not only want to measure the refractive index of samples, but several additional parameters like density or viscosity to perform efficient quality control. Due to the microprocessor control and a number of interfaces, automatic refractometers are able to communicate with computers or other measuring devices, e.g. density meters, pH meters or viscosity meters, to store refractive index data and density data (and other parameters) into one database.

Influence of wavelength. The refractive index of a certain sample varies for nearly all materials for different wavelengths. This dispersion relation is characteristic for every material. In the visible wavelength range a decrease of the refractive index and nearly no absorption is observable. In the infrared wavelength range several absorption maxima and fluctuations in the refractive index appear. To guarantee a high quality measurement with an accuracy of up to 0,00002 in the refractive index the wavelength has to be determined correctly. Therefore, in modern refractometers the wavelength is tuned to a bandwidth of $\pm 0,2$ nm to ensure correct results for samples with different dispersions.

Influence of temperature. Temperature has a very important influence on the refractive index measurement. Therefore, the temperature of the prism and the temperature of the sample have to be controlled with high precision. There are several subtly different designs for controlling the temperature but there are some key factors common to all such as high precision temperature sensors and Peltier devices to control the temperature of the sample and the prism. The temperature control accuracy of these devices should be designed so that the variation in sample temperature is small enough that it will not cause a detectable refractive index change.

MODULE 3

WATER QUALITY CONTROL

Topic 6

Pharmacopoeial methods for water quality control. Methods for water determination in drugs

Objective: 1) study pharmacopoeial methods for production and quality control of water used in pharmacy; 2) learn the methods for water content determination in the API and dosage forms.

1. Gradation of water in accordance with its use in drugs. Methods of water production.

Pharmacopoeias of different countries classify the water for medical use in several ways (Table 6.1).

Table 6.1

Classification of water in different states pharmacopoeias

USP	Ph. Eur., BP	Russian State Pharmacopoeia
Bacteriostatic for Injection [*]	—	—
Pure Steam	—	—
Purified Water	Purified Water	Purified Water
—	Highly Purified Water	—
Sterile Purified Water	—	—
Sterile Water for Inhalation	—	—
Sterile Water for Injection	Sterilised Water for Injection	Water for Injection
Sterile Water for Irrigation	—	—

USP	Ph. Eur., BP	Russian State Pharmacopoeia
Water for Hemodialysis	–	–
Water for Injection	Water for Injection	–

Notice: * – Solution of sterile water and 0,9–1,1% benzyl alcohol as an antimicrobial preservative.

According to the Russian State Pharmacopoeia, the water for medical use must meet the basic requirements of pharmacopoeia monograph FS 42-0324-09 «Purified water» and FS 42-0325-09 «Water for Injection» (Table 6.2).

Table 6.2

**Production and use of water
(Russian State Pharmacopoeia XII)**

	Purified Water	Water for Injection
Definition	Water for the preparation of medicines other than those that are required to be both sterile and apyrogenic, unless, otherwise justified and authorized	For manufacture of the drugs for parenteral administration or for sterile drug production in aseptic conditions without subsequent sterilization (sterile water for injection)
Production	from drinking water by distillation, ion exchange, reverse osmosis or other suitable method	from purified water in the distillation apparatus of neutral glass or quartz or a suitable metal

Water as the reagent used in the chemical, physico-chemical and biological tests, must meet common and specific requirements. In most cases, the water used for analytical purposes must meet the basic requirements of pharmacopoeia monograph «Purified water» (Table 6.3).

**Requirements for purified water
(FS 42-0324-09)
and frequency of quality control**

Tests	Norms	Frequency of quality control
pH	5,0–7,0	Daily
Acidity or alkalinity	Yellow coloration with phenolic red, turning to red when you add sodium hydroxide and turning into yellow by the addition of hydrochloric acid	1 time a month*
Conductivity	Not more than 5,1 $\mu\text{S}/\text{cm}$ (25 °C)	Daily
Residue on evaporation	Not more than 0,001%	1 time a month*
Oxidisable substances	Pink color persists in the sample with potassium permanganate	1 time a month*
Carbon dioxide	No turbidity for 1 h. in the reaction with lime-water	1 time a month*
Nitrates, Nitrites	No blue color in the reaction with diphenylamine	1 time a month*
Ammonium	Not more than 0,00002%	1 time a month*
Chlorides	Absence of opalescence in the reaction with silver nitrate	1 time a month*
Sulfates	No change in appearance for at least 1 h. in reaction with barium chloride solution	1 time a month*
Calcium and Magnesium	Pure blue color is produced in reaction with sodium edetate solution	1 time a month*
Heavy metals	No change in appearance	1 time a month*
Microbiological purity	Not more than 100 microorganisms per 1 mL of the bacteria in the absence of Enterobacteriaceae, Staphylococcus	For chemical purposes is not less than 1 time per month; for

Tests	Norms	Frequency of quality control
pH	5,0–7,0	Daily
	aureus, Pseudomonas aeruginosa	microbiological purposes – 2 times a month

Notice: * – Unscheduled water quality analysis is performed when there is suspicion of deterioration.

Water for analytical purposes is prepared in the laboratories by distillation (in distillers or apparatus for purified water production (ion exchange, reverse osmosis, etc.).

Water for analytical purposes is collected and stored in the containers (except the cases when it's required using freshly prepared water). Containers should be sanitized routinely 1 time in 4 months, unscheduled – in excess of microbiological anxiety level.

Other types of water used in the laboratory

Distilled water (Russian State Pharmacopoeia) – water produced by distillation.

Water for chromatography (Russian State Pharmacopoeia XII) – deionized water with a resistivity of not less than 0,18 Mohm·m.

Distilled water, deionized (Ph. Eur.) – deionised water prepared by distillation with a resistivity of not less than 18 Mohm·m.

Purified water R1 (Ph. Eur.) prepared from distilled water R by multiple distillation or by any other suitable method from water that complies with the regulations on water intended for human consumption laid down by the competent authority. The boiling flask has been already used for the test or has been filled with water R and kept in an autoclave at 121 °C for at least 1 h prior to first use. When tested immediately before use, water is neutral to methyl red solution, i.e. it shall produce an orange-red (not a violet-red or yellow) color corresponding to pH $5,5 \pm 0,1$

when 0,05 ml of methyl red solution is added to 50 ml of the water to be examined. Conductivity: maximum 1 $\mu\text{S}/\text{cm}$ (25 °C).

Water, ammonium-free (Russian State Pharmacopoeia). To 100 ml of purified water add 0,1 ml of sulphuric acid, distil and reject the first 10 ml and collect the following 50 ml.

Water, carbon dioxide-free (Russian State Pharmacopoeia XII). Purified water which has been boiled for a few minutes and protected from the atmosphere during cooling and storage.

Water, nitrate-free (Russian State Pharmacopoeia). To 100 ml of purified water add a few milligrams of potassium permanganate and of barium hydroxide, distil, reject the first 10 ml and collect the following 50 ml.

Water, particle-free (Russian State Pharmacopoeia). Filter purified water through a membrane with a pore size of 0,22 μm .

Methods for water content determination. Many drugs either are hydrates or contain water in adsorbed form. As a result, the determination of the water content is important in demonstrating compliance with the Pharmacopoeial standards.

Generally, one of the methods for water content determination given below is included in the normative document depending upon the nature of the drug.

When the drug contains water of hydration, the Titrimetric Karl Fisher method, distillation method (azeotropic), or the gravimetric method («loss on drying») is employed, as directed in the normative document, and the requirement is given under the heading Water.

It should be mentioned that the «loss at drying» test is carried out in those cases where the weight loss on heating is connected not only with water loss.

The titrimetric methods for water content determination are based upon the quantitative reaction of water with an anhydrous solution of sulfur dioxide and iodine in the presence of a buffer that reacts with hydrogen ions.

The original titrimetric solution, known as Karl Fischer Reagent, is a solution of sulfur dioxide SO_2 and iodine I_2 , pyridine $\text{C}_5\text{H}_5\text{N}$ or imidazole $\text{C}_3\text{H}_4\text{N}_2$ in methanol CH_3OH .

It reacts with water stoichiometrically in two stages by the equations:

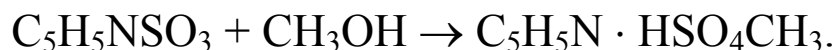
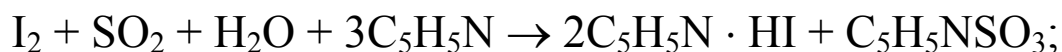

Water content (%) is calculated as follows:

$$\omega\% = \frac{(V_o - V_k)T100\%}{m},$$

where V_o – volume of K. Fisher reagent spent on titration of tested sample, ml;

V_k – volume of K. Fisher reagent spent on titration of blank, ml;

m – sample weight, g;

T – titer of K. Fisher reagent, g/ml.

In accordance with the OFS «Determination of Water» of Russian State Pharmacopoeia XIV there are:

– Karl Fischer method (semimicro-method, volumetric titration), which is used to determine large amounts of water in the samples (from 0,1 to 100%). In this case volumetric titration reagent is added to the sample with a burette or other exact dosing device. In this method, standardization of the reagent (titrant) and the accuracy of its dosing strongly influence on the uncertainty of the measurements. When sample contains low amount of water, accuracy of reagent dosing is critical.

– micro-determination of water (coulometric titration) – when iodine necessary for the K. Fisher reaction is formed by anodic oxidation of iodide ion:

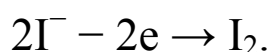

Produced iodine reacts with the water presented in the sample and sulfur dioxide in the presence of a organic base. Iodine reacts as long as water is present in the medium. Excess of iodine indicates the end point of the titration. The amount of titrated water in proportion to electricity passed through the cell

(1 mol of iodine is equivalent to 1 mol of water, and the amount of electricity equals 10,71 Cl corresponding to 1 mg of water).

Coulometric titration is used for quantitative determination of trace amounts of water, from 0,001 to 1% (absolute water content of 10 to 200 mg). Accuracy and precision of this method should be provided by atmospheric moisture removal from the system.

For the **water content determination by distillation method** (azeotropic method) apparatus, presented on Fig. 6.1, is used. It consists of a glass flask (*A*) with a capacity of 250 to 500 ml, the receiver (*B*), which is a graduated burette tube with capacity of 6–10 ml dividing 0,1 ml, cooler (*C*) and reflux condenser (*C*).

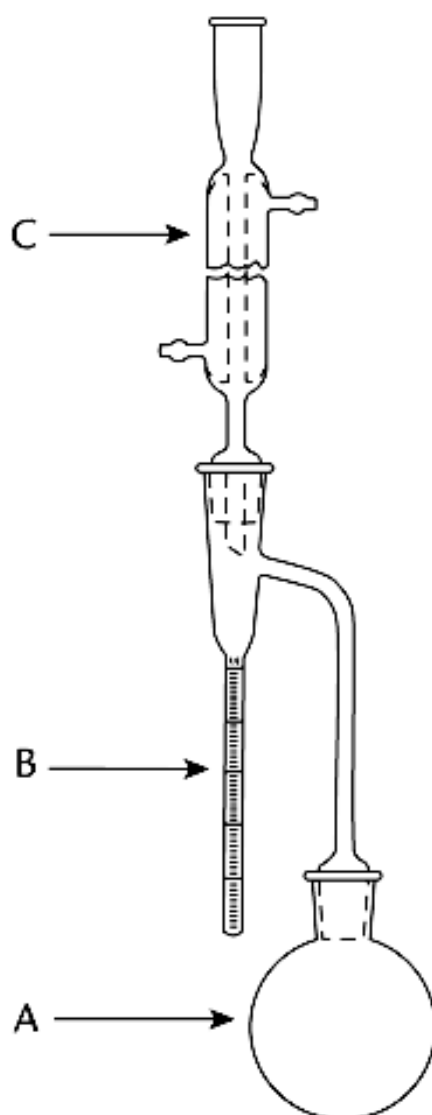

Fig. 6.1. Apparatus for the determination of water by distillation

Place the amount of test substance (from 10 to 20 g, containing from 2 to 3 ml of water specified in relevant pharmacopoeial monograph) into the dry flask (*A*), add 100 ml of toluene or xylene and a few pieces of porous material (e.g. pumice-stone) or glass capillaries. Heat the flask gently in a sand bath or hot plate. When the toluene begins to boil, distil at the rate of about two drops per second until most of the water has distilled over, then increase the rate of distillation to about four drops per second. Boiling should be stopped when the volume of water in the receiver ceases to increase and the upper solvent layer at the receiver becomes transparent. After complete separation, mark the volume of distilled water and calculate the content in the sample ($w, \%$).

To determine the **loss on drying** (gravimetric method) the precisely weighed amount, specified in the pharmacopoeial monograph, of test substance is placed in a pre-dried and weighed bottle. The substance is dried to a constant weight during the time specified in a pharmacopoeial monograph by the following ways:

1. Drying in an oven within a temperature range, described in the pharmacopoeial monograph. The substance is dried to constant weight at a temperature from 100 to 105 °C, unless otherwise indicated.

2. Drying in a desiccator over phosphorus oxide (*V*):

- at atmospheric pressure and room temperature;

- in a vacuum at room temperature or at the temperature specified in the pharmacopoeial monograph

- in a «deep vacuum»: the pressure of not more than 0,1 kPa at a temperature, specified in pharmacopoeial monograph.

Result is expressed as mass percentages ($w, \%$).

MODULE 4
CHEMICAL ANALYSIS
FOR MEDICINES QUALITY CONTROL

Topic 7

Chemical analysis for medicines quality control.
Precipitate and chromogenic reactions

Objective: to create a system of knowledge about the chemical pharmacopoeial methods of medicines quality control on the example of some precipitate and chromogenic reactions.

Chemical control includes the assessment of drug quality on indicators «identification», «impurities limit tests» (qualitative analysis) and quantitative determination of API in the drug composition («Assay»).

An active development of instrumental analysis methods has been seen recently in the field of analytical chemistry. New analytical methods based on complex physical phenomena and characterized by low detection limit and threshold drug concentration are being constantly introduced. However pharmacopoeias of different states not only haven't abandoned chemical quality control methods, but also actively use them both in monographs and in general pharmacopoeial articles. This is explained by some advantages of chemical methods such as: ease of implementation, clarity, accuracy and reproducibility (for quantitative analysis), as well as economic benefit.

General principle of chemical methods for determining drug identity and purity is the utilization of reactions with so-called chromogenic (color-) reagents. Reagents, used to analyze medicines, are divided into *specific*, *selective* and *group*. Sedimentation reagents, called alkaloidal precipitating agents, are

also widely used in the analysis of the organic nature drugs. Then the analytical signal – change of solution color, gas or sediment evolution, and flame coloration – is simply visually observed or compared with the color intensity scale of the standard samples.

Peculiarities of conducting the chromogenic reactions:

- The sample must be placed in a clean glass container (vial, bottle, plate) or in order to conserve reagents it is possible to use the surface of white glazed tile or cup with a uniform background.

- It is required to use a control sample (blank) and a reference standard (positive control). Control sample – a sample, which obviously does not contain the test components, e.g. distilled water. Standard sample – a sample of the substance, the chemical composition and properties of which are determined with the necessary accuracy and are permanently high.

- Subjectivity – the intensity of color perception is determined by analyst individuality.

- There are few specific analytical reagents, selective and group reagents are mainly used.

Examples of chromogenic reactions:

1. Formation of ferric and copper colored hydroxamate complexes. Hydroxylamine hydrochloride $\text{NH}_2\text{OH HCl}$ is a powerful reducing agent with the ability to participate in nucleophilic substitution reactions with the formation of hydroxamic acids. Different medicinal substances and their transformation products belong to the class of carboxylic acid derivatives – acid chlorides, anhydrides, esters, amides, lactones and lactams – and contain an electrophilic center – carbonyl carbon:

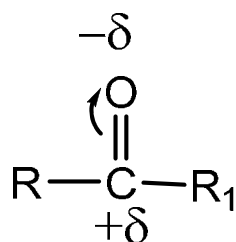

When exposed to a nucleophilic agent – the hydroxylamine – $\text{H}_2\ddot{\text{N}}\leftarrow\text{OH}$, these compounds are easily converted into hydroxamic acids $\text{RCO}(\text{NHOH})$. For example, the reaction of hydroxamic acid sodium salt formation for the corresponding carboxylic acid chloride can be written as follows:

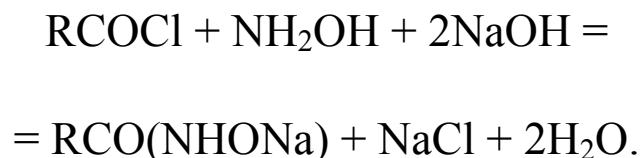

In weak-acid solutions all hydroxamic acids react with $\text{Fe}(\text{III})$ and $\text{Cu}(\text{II})$ salts to produce a coloured complex.

For example, an ester – reserpine react with hydroxylamine, the product of reaction – hydroxamic acid with FeCl_3 produces a red-violet complex salt with a central atom Fe^{3+} :

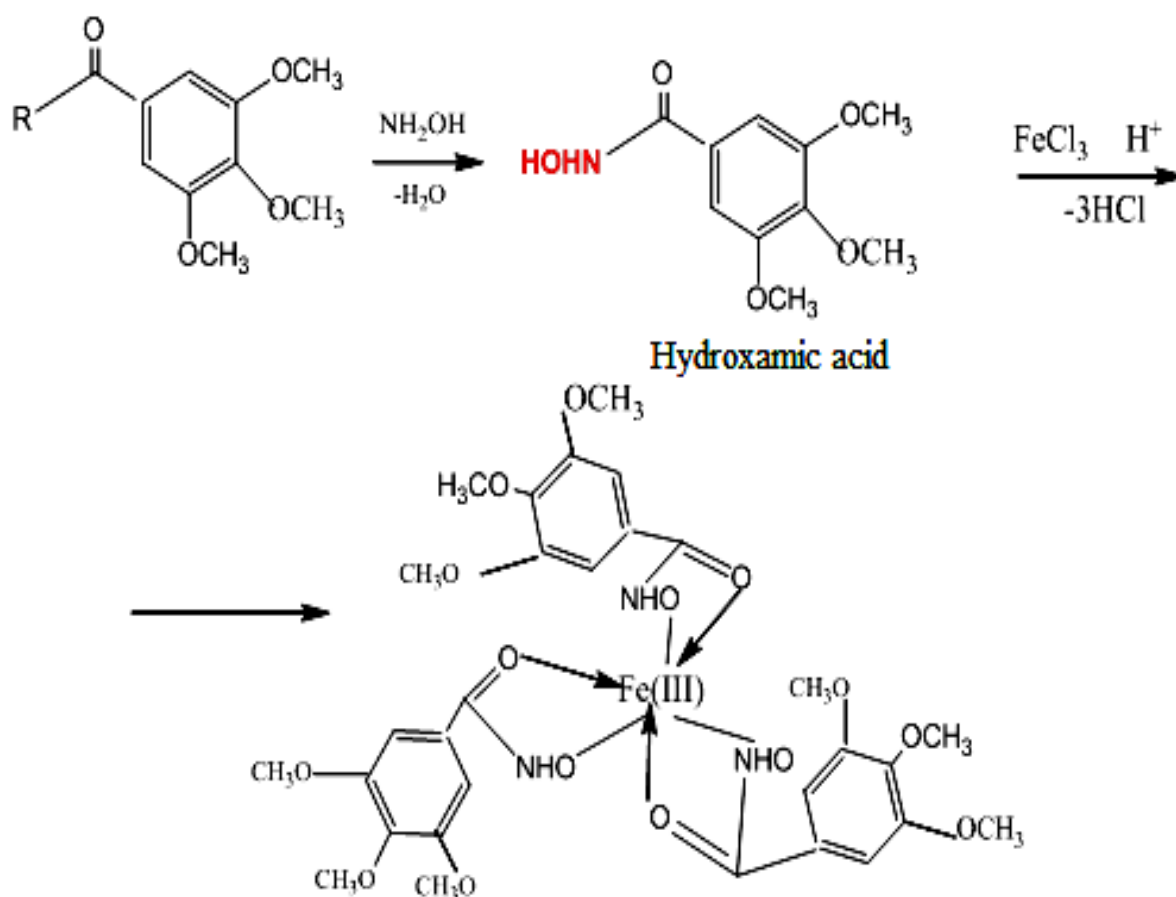

Formed complex has an octahedral structure:

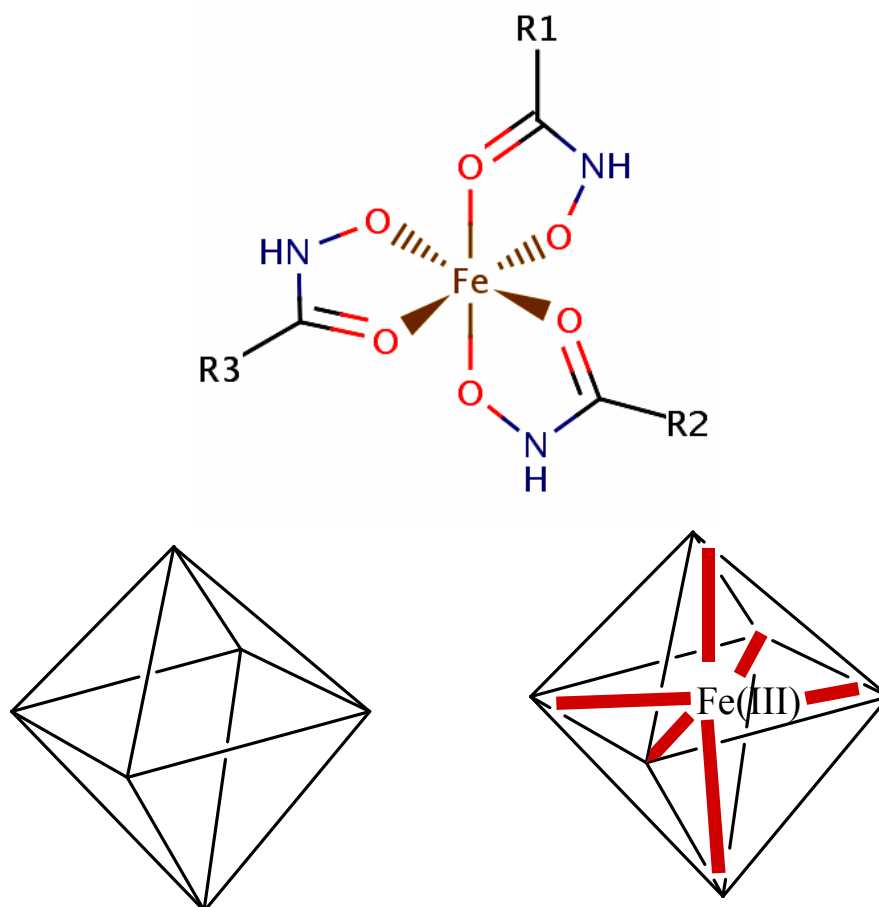

Hydroxamic reaction with lactone – benzopyrane takes the view:

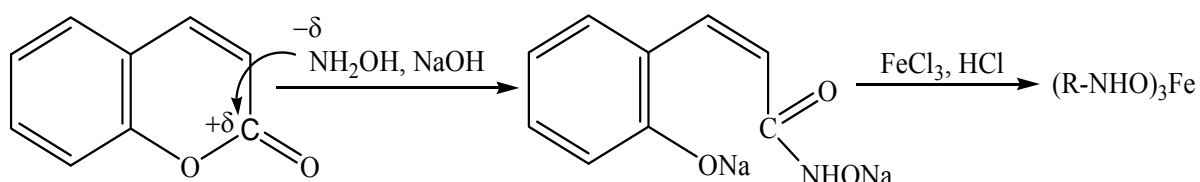

2. Reaction of azo dye formation is another example of test, often used in pharmacopoeias. Azo dyes are organic compounds containing one or more azo groups $-\text{N}=\text{N}-$, which link aromatic radicals. Reaction of azo dye formation is a qualitative test on primary aromatic amines.

This reaction is followed by next analytical effects: *cherry-red coloring of mixture or orange-red precipitate*. Sometimes it is required to conduct some hydrolysis reaction before azo dye formation test, e.g. transformation of secondary amine to the primary group or nitro group $-\text{NO}_2$ reduction to an amino group $-\text{NH}_2$.

Stages of azo dye formation:

■ **Diazotization** – the process of forming diazonium compounds. The most important method for the preparation of diazonium salts is treatment of aromatic amines with nitrous acid. Nitrosation involves the formation of nitrosyl cation during acidification of nitrite. Usually the nitrous acid is generated in situ (in the same flask) from sodium nitrite and mineral acid:

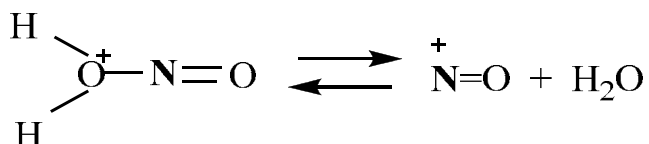
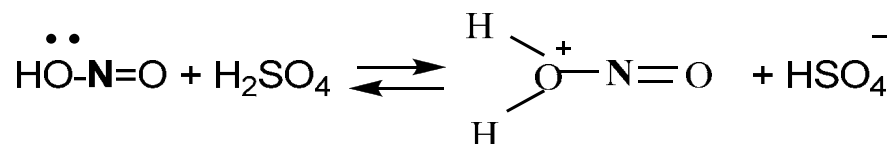
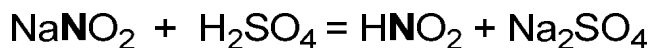

The nitrosyl cation then reacts with an amine to form diazonium salt:

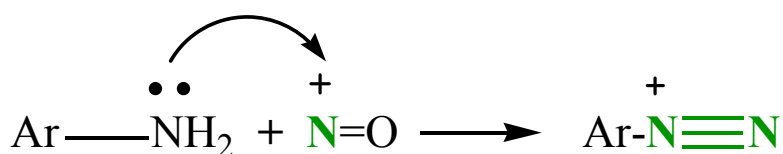

Reaction of diazonium salt formation in general form is written as:

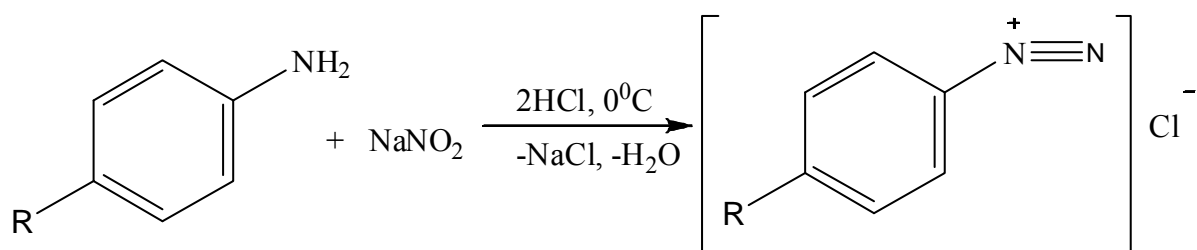

In aqueous solution diazonium salts are unstable at temperatures above +5 °C; the $-\text{N}^+ \equiv \text{N}$ group tends to be lost as N_2 (nitrogen gas). Therefore, diazonium compounds usually are not isolated and once prepared, used immediately in further reactions.

■ The azo coupling represents an electrophilic aromatic substitution. The diazonium cation is a relatively weak electrophile. Therefore, the aromatic ring, which it attacks, must have an activating group such as -OH or -NH₂. Electron withdrawing groups on the aromatic ring of the diazonium ion facilitate the substitution reaction. Electrophilic substitution of β-naphthol occurs preferentially at the 1-position. The NH₂ group in 1-naphthylamine activates the 2- and 4-position. For example, substitution of β-naphthol occurs as follows:

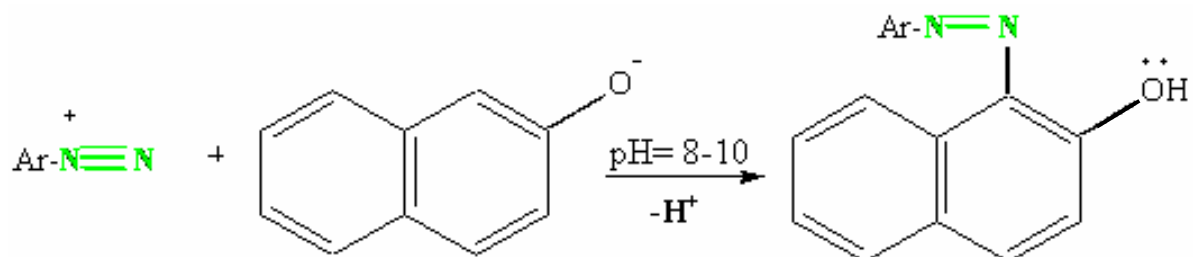

At acidic pH, the concentration of ionized diazonium molecules will be low thereby the reaction rate reduces. At pH higher than 10, diazonium salt converts into diazohydroxide, which does not exhibit the properties of an electrophilic particle. Azo coupling with aromatic amines takes place in a wider pH range (4–10).

In azo compounds the -N = N⁻ group is part of an extended delocalized electron system involving the aromatic rings, called a chromophore. Groups such as -OH and -NH₂ attached to chromophores modify the colors of the dyes. For example, Ph. Eur. often recommends using naphthylethylenediamine instead of naphthol:

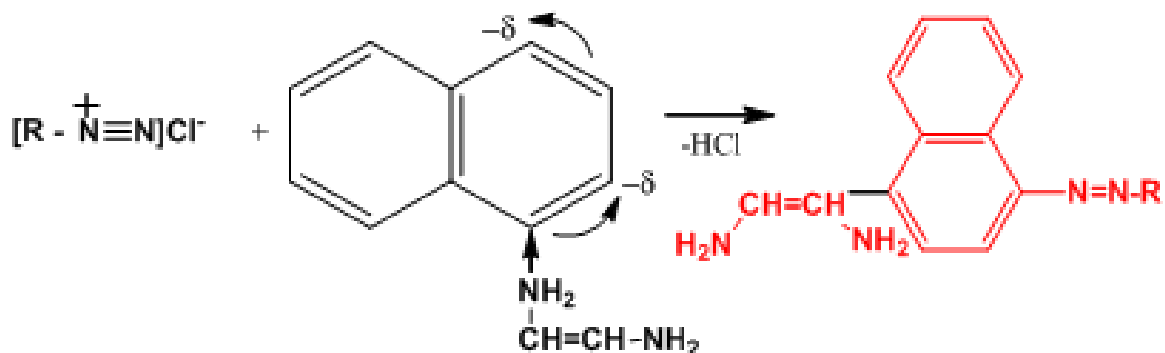

Chromogenic chain formed with this reagent is longer, so the coloration intensity of final azo dye is higher.

3. Reaction of azomethine dye formation occurs in the interaction of aromatic aldehyde with aromatic amine, diamine or hydrazine on heating. For example, aromatic aldehyde with isoniazid results in Ftivazid. Ftivazid – light yellow or yellow crystalline powder with a faint odor of vanilla, the color is determined by the presence of azomethine group in Ftivazid structure:

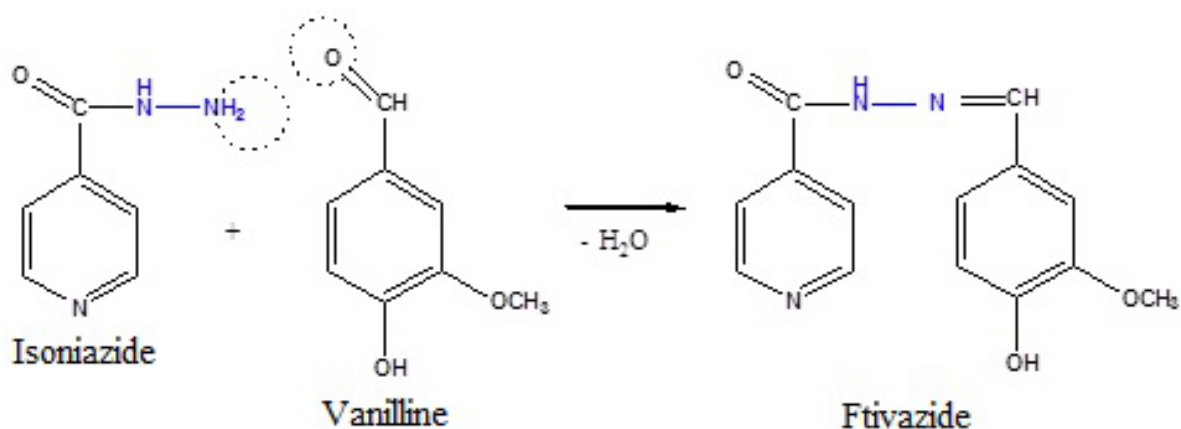

4. Reaction of arylmethane dyes formation is also used in the identification of the different drugs. Aryl methane dyes are so called because they are derived from methane, but in which some of the hydrogen atoms are replaced with aryl rings.

This group dyes are formed by condensation of aromatic aldehydes or formaldehyde with aromatic amines and phenols, for example, quinoline:

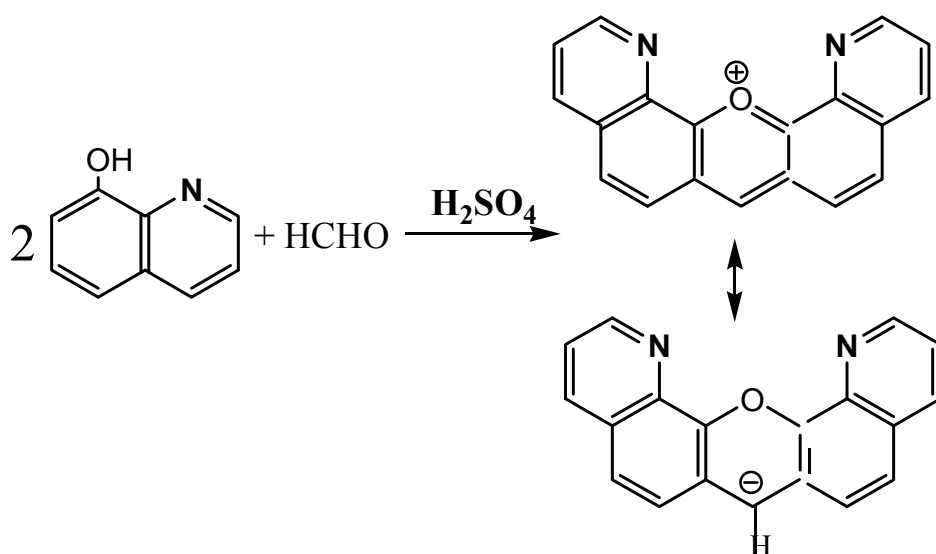

The color of final compound is due to the existence of ionic mesomeric forms containing chromogenic chain. Colors of arylmethane dyes depend on the nature of the substrate and can vary from pink to red-violet. Some authors describe the mechanism of arylmethane dye formation in another way:

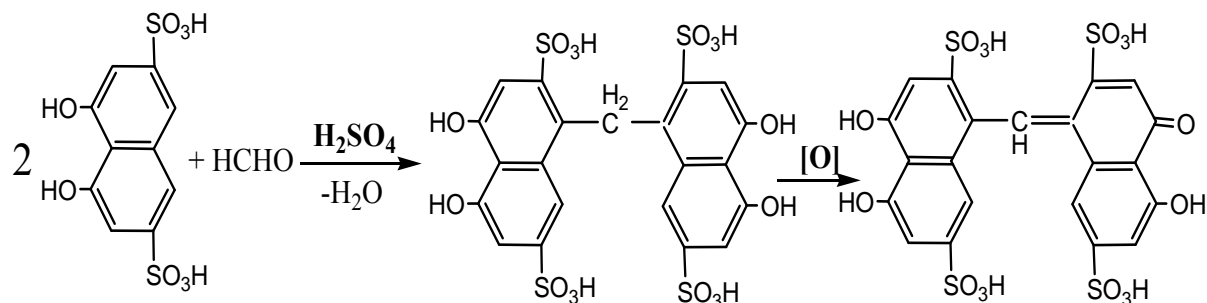

5. Reaction of indophenol dye formation is applied to detect phenols and para-aminophenols. For example, the reaction of pyridoxine containing phenolic hydroxyl with 2,4-dichloro(bromo) quinone-chloroimine produces blue indophenol dye:

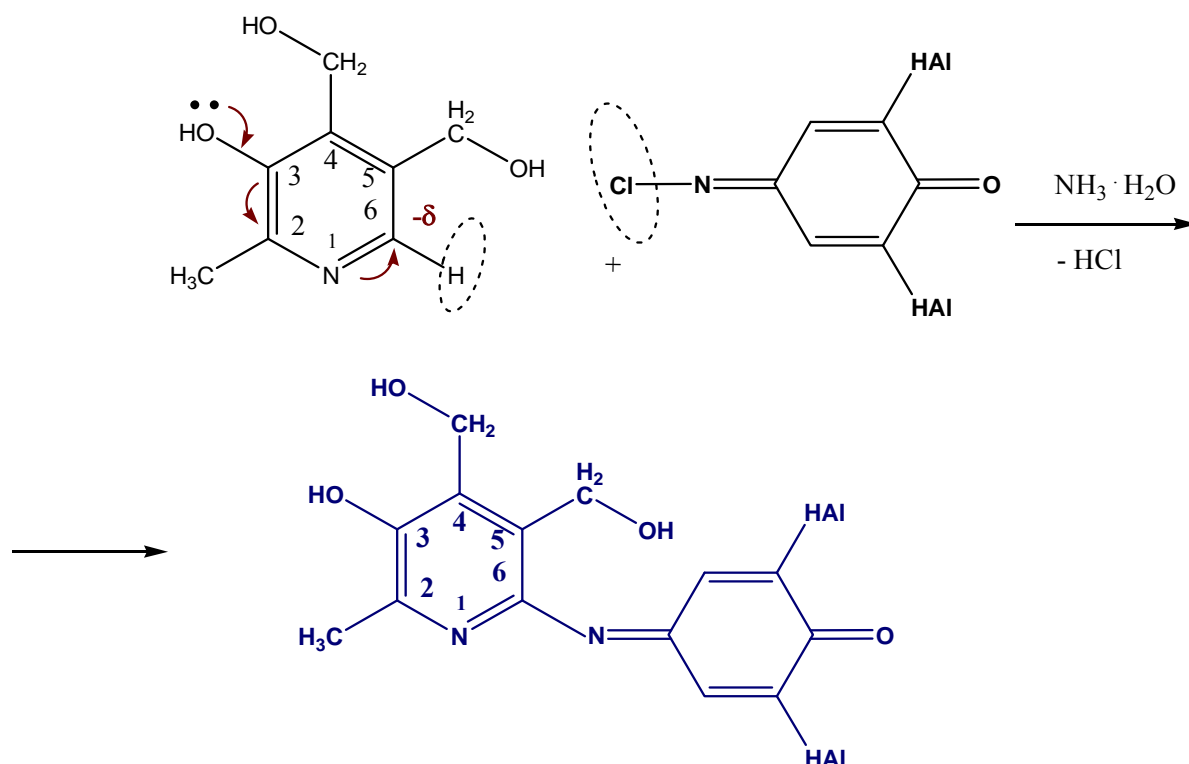

Indophenol dyes reversibly change their color at different pH level.

6. A large number of drugs are organic bases or their salts. These include nitrogen-containing aliphatic, aromatic, heterocyclic compounds, alkaloids, vitamins, hormones and antibiotics.

Sedimentation reagents, called alkaloidal precipitating agents, are used for identification of drugs that are organic bases and their salts. The reaction produces amorphous or crystalline precipitate, which has a characteristic melting point.

Alkaloidal precipitation agents are inorganic acido complexes (Wagner's Reagent: Iodine/ Potassium Iodide) or weak organic acids (picric acid, tannin – a mixture of gallic acids) (Table 7.1).

Table 7.1

Some alkaloidal precipitation agents

Name	Chemical composition	Precipitate color
Wagner's – Bouchard's – Lugol's reagent (solution of iodine in potassium iodide – different concentrations)	$K[I_3]$	greyish-brown
Dragendorff's reagent (potassium iodobismuthate)	$K[BiI_4]$	orange or red
Mayer's reagent (potassium mercuric iodide)	$K_2[HgI_4]$	white or light yellow
Marme's reagent (solution of cadmium iodide in potassium iodide)	$K_2[CdI_4]$	white
Sheiber's reagent (phosphotungestic acid)	$H_3PO_4 \cdot 12WO_3 \cdot 2H_2O$	white
Zonnenschein's reagent (phosphomolybdic acid)	$H_3PO_4 \cdot 12MoO_3 \cdot 2H_2O$	grayish-brown or light yellow
Bertran's reagent (silicotungestic acid)	$SiO_2 \cdot 12WO_3 \cdot 2H_2O$	white
Mercurous chloride (II)	$HgCl_2$	white
Chloroplatinic acid	$H_2[PtCl_6]$	white
Hager's reagent (picric acid)	$C_6H_3N_3O_7$	yellow

In acidic pH anions of organic acids and acido complexes form with alkaloids and other substances of base character precipitating ionic associates.

Sensitivity of precipitation reagents to alkaloids varies. The most sensitive agent is phosphotungestic acid, the least sensitive reagents – tannin and picric acid (Fig. 7.1).

Reducing sensitivity of precipitation reagents

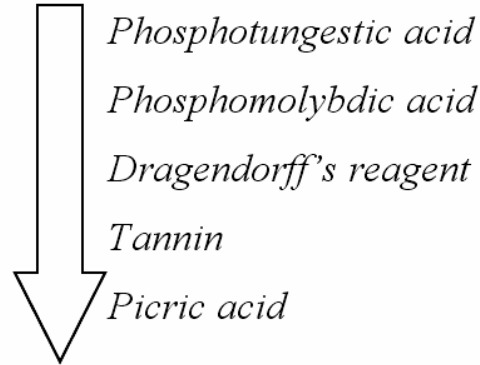

Fig. 7.1. Reducing sensitivity of precipitation reagents

Topic 8

Chemical analysis for medicines quality control. Pharmacopoeial titrimetric methods

Objective: form a system of knowledge about the titrimetric pharmacopoeial methods for drugs quality control.

Titrimetric method of analysis is based on measuring the reagent volume with known concentration, spent on reaction with the analyte being determined.

Titration – the gradual addition of reagent (titrant) to the sample solution for the equivalence point determination.

Equivalence point – the time of titration when the equivalent ratio of the reactants is achieved.

End point – the time of titration, which is determined by the volume of titrant, spent for the titration. End point is often determined by the indicator's colour change or potential jump.

Chemical reactions used for titration methods should meet following requirements:

- The reaction should be irreversible and should proceed in accordance with a stoichiometric equation and without adverse reactions

- The reaction should proceed at a sufficiently high rate.

- There must be a way to fix the equivalence point. Completion of the reaction should be determined easily.

Depending on the type of reaction titrimetric methods are divided into:

1. Acid-base titration (alkalimetry, acidimetry).
2. Redox titration (titration with KMnO_4 , iodometric titrations, diazotisation titrations, titration with KBrO_3 , titration with cerium (IV) salts).
3. Precipitation titration (argentimetric titrations).
4. Complexometric titration.

Indicator selection also depends on the type of reaction: acid-base indicators – phenolphthalein, methyl red, methyl orange, phenol red, and others; starch solution is used in iodometric titrations, tropeolin OO for diazotisation titrations, in argentometric titrations solutions K_2CrO_4 , $FeSO_4$, etc. are used; murexide is applied in complexometric titrations.

Advantages of titrimetric methods are:

- high rate of analysis;
- equipment simplicity;
- ability for analysis automation;
- high accuracy and reproducibility.

Types of titration used in pharmaceutical analysis

1. **Direct titration** when titrant is added in small portions to a test solution with analyte. Example: alkalimetric determination of aspirin. Indicator phenolphthalein changes its color (pink color appearance) at the endpoint.

At the equivalence point products (salt – sodium acetylsalicylate and water) are formed:

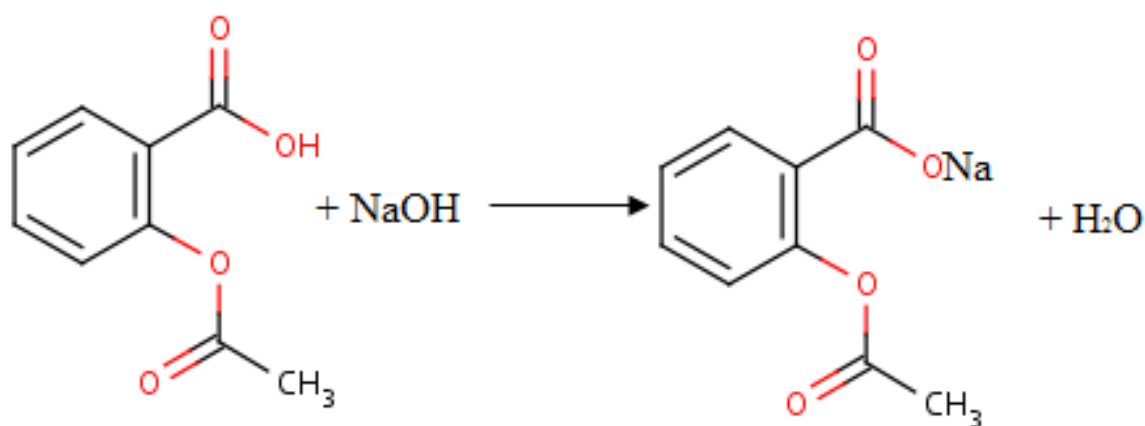

Analyte reacts directly with the titrant and in accordance with the equivalents law, equivalence factor $1/z = 1$:

$$n(\text{NaOH}) = n(\text{aspirin});$$

$$n(\text{aspirin}) = C(\text{NaOH}) \cdot V(\text{NaOH}).$$

2. In **Back titration (titration of residue)** two titrant solutions are used. Excess of the first titrant (titrant 1) solution is

added to the tested sample. The residue of titrant is back titrated with the second titrant (titrant 2). The amount of titrant 1 consumed by reacting with the analyte is determined by the difference between the added volume (V_1) and the volume (V_2) of titrant 2. Example: acidimetric determination of lithium carbonate:



$$V(\text{HCl}) = V_1;$$



In the back titration in accordance with the equivalents law:

$$n(1/z \text{Li}_2\text{CO}_3) = n(1/z \text{HCl}) - n(1/z \text{NaOH});$$

$$n(1/z \text{Li}_2\text{CO}_3) = C(1/z \text{HCl}) \cdot V_1 - C(1/z \text{NaOH}) \cdot V_2;$$

$$\text{or } n(1/z \text{Li}_2\text{CO}_3) = C(1/z \text{HCl}) \cdot \Delta V, \text{ where: } \Delta V = V_1 - V_2.$$

3. Substitution (indirect) titration is used in cases when the direct or back titration is not possible or is difficult, that is, the immediate reaction between analyte and titrant does not meet the requirements of the reactions used in titrimetric analysis. Reagent (titrant 1) is added to an analyte, in the result of this interaction reaction product is quantitatively formed. Then the product is titrated with titrant 2. Example: determination of sodium nitrite by titration with cerium (IV) salt:

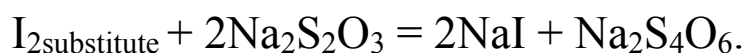
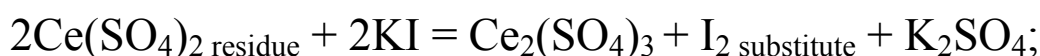
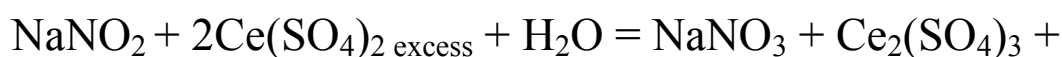

In the substitution titration in accordance with the equivalents law:

$$n(1/z \text{ NaNO}_2) = n(1/z \text{ Ce(SO}_4)_2) - n(1/z \text{ Na}_2\text{S}_2\text{O}_3);$$

$$n(1/z \text{ NaNO}_2) = C(1/z \text{ Ce(SO}_4)_2) \cdot V_1 - C(1/z \text{ Na}_2\text{S}_2\text{O}_3) \cdot V_2.$$

Depending on the solvent titration is divided into *aqueous* and *nonaqueous*. The main advantage of a non-aqueous titration is the ability to titrate with sufficient trueness not only strong acids and bases, but also weak and very weak acids, bases and salts. Furthermore, the method can determine nonaqueous titration substance poorly soluble in water. Method nonaqueous titration gives more accurate results than accuracy of titration in aqueous solutions, due to small surface tension drop size of organic solutions is smaller than drop size of aqueous solutions.

The choice of solvent depends on the nature of the analyte: for weak bases protogenic solvents are used – acetic and formic acid, acetic anhydride, etc., for the weak organic acids protophilic solvents are applied – dimethylformamide, acetone. Frequently ethanol is applied in this case the selection is based only on the solubility of the tested substance.

Example: scheme of non-aqueous titration of the drug, weak organic base. In the initial titration solution (HClO_4 in anhydrous CH_3COOH) equilibrium is established:

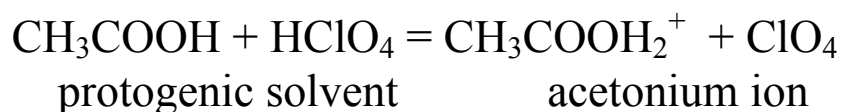

In the titrated solution:

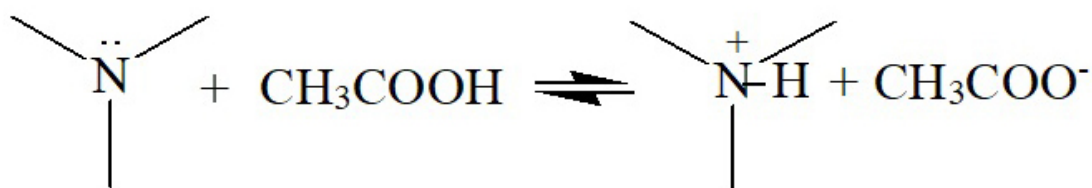

During the titration:

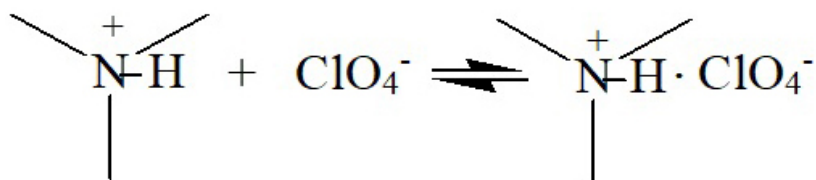

Possible water impurity should be excluded, however acetic anhydride is added:



For end-point determination amperometric and potentiometric methods are used in addition to the indicators.

Potentiometric titration is based on the determination of the equivalence point on a potential jump (Fig. 7.1). It is observed when at least one of the reactants of the reaction process is a member of the electrode process. For example, titrations based on acid-base interaction can be performed using as a working electrode – pH-sensitive glass electrode. Most of the working electrode is an inert metal (platinum, gold, etc.). The role of the reference electrode plays an electrode with a stable value of the potential, for example silver/silver chloride (Ag / Cl⁻, AgCl).

For end-point determination differential curve with coordinates

$$dE/dV - V$$

is easy to use. The equivalence point corresponds to the maximum on the differential titration curve (Fig. 8.1).

Amperometric titration is based on the measurement of the limiting diffusion current proportional to the concentration of the electroactive component. At the equivalence point there is a sharp change in current (Fig. 8.2).

Amperometric titration curve is a plot of amperage of the volume of titrant consumed. Depending on the type of reaction

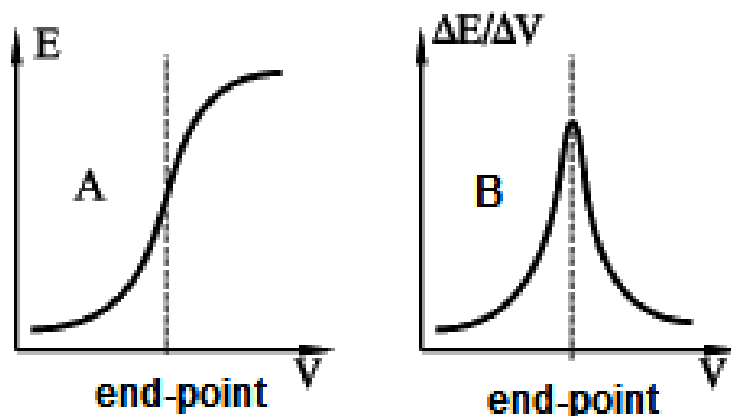

Fig. 8.1. Determination of equivalence point by means of integral (A) and differential (B) potentiometric titration curves

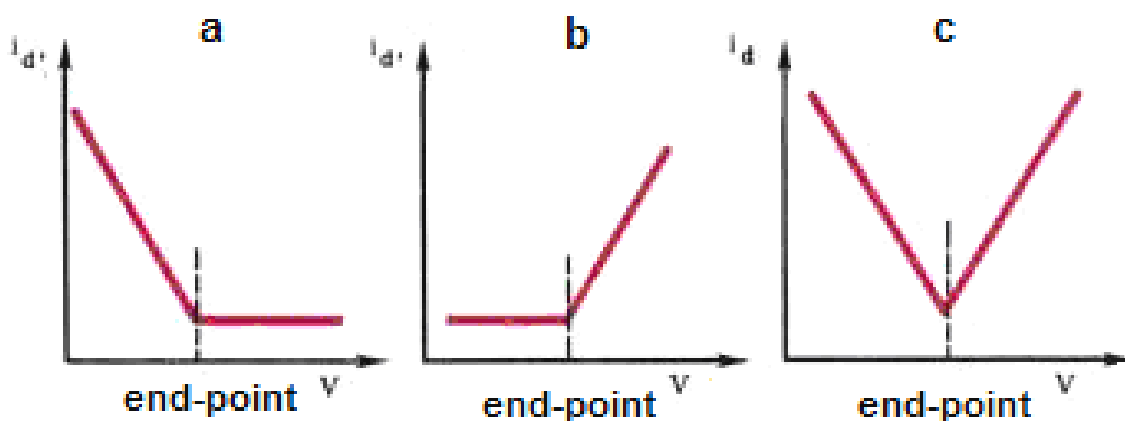

Fig. 8.2. Examples of amperometric titration curves. Electroactive compounds: a – analyte, b – titrant, c – analyte and titrant

and the substance involved in the electrode reactions, different shapes of curves are observed.

General chapters «Potentiometric titration» and «Amperometric titration» are included in JP and Eur. Ph. USP contains general chapter «Titrimetric methods of analysis». Russian State Pharmacopoeia XII contains OFS «Nitritometric Titration», which describes the quantitative determination of primary aromatic amines.

MODULE 5

SPECTRAL ANALYSIS FOR DRUG QUALITY CONTROL

Topic 9

Ultraviolet (UV) and visible spectrophotometry for medicines quality control

Objective: to learn the theoretical and practical foundations of ultraviolet and visible spectroscopy; assess the quality of medicine using UV/visible spectroscopy.

The spectrophotometer has well been called the workhorse of the modern laboratory. In particular, ultraviolet and visible spectrophotometry is the method of choice in most laboratories concerned with the identification and measurement of organic and inorganic compounds in a wide range of products, including, pharmaceuticals. In every branch of molecular biology, medicine and the life sciences, the spectrophotometer is an essential aid to both research and routine control.

Modern spectrophotometers are quick, accurate and reliable and make only small demands on the time and skills of the operator. However, the user who wants to optimise the functions of his instrument and to be able to monitor its performance in critical areas will need to understand the elementary physics of the absorption process as well as the basic elements of spectrophotometer design.

The electromagnetic spectrum. Man lives in an environment that is permanently exposed to naturally occurring electromagnetic radiation, some of which he detects with his own senses. Radiant heat from the sun is recognised by the body as warmth while the eye responds to light to give the power of sight. But the visible spectrum, that part of the whole spread of wavelength to which the human eye is sensitive, is a very small part of the total

range. The familiar rainbow colors extend in one direction beyond red through infrared to microwaves and radio waves (increasing wavelength) and in the other direction past violet to ultraviolet and then, with progressively diminishing wavelength, via X-rays and gamma rays to cosmic rays (Fig. 9.1).

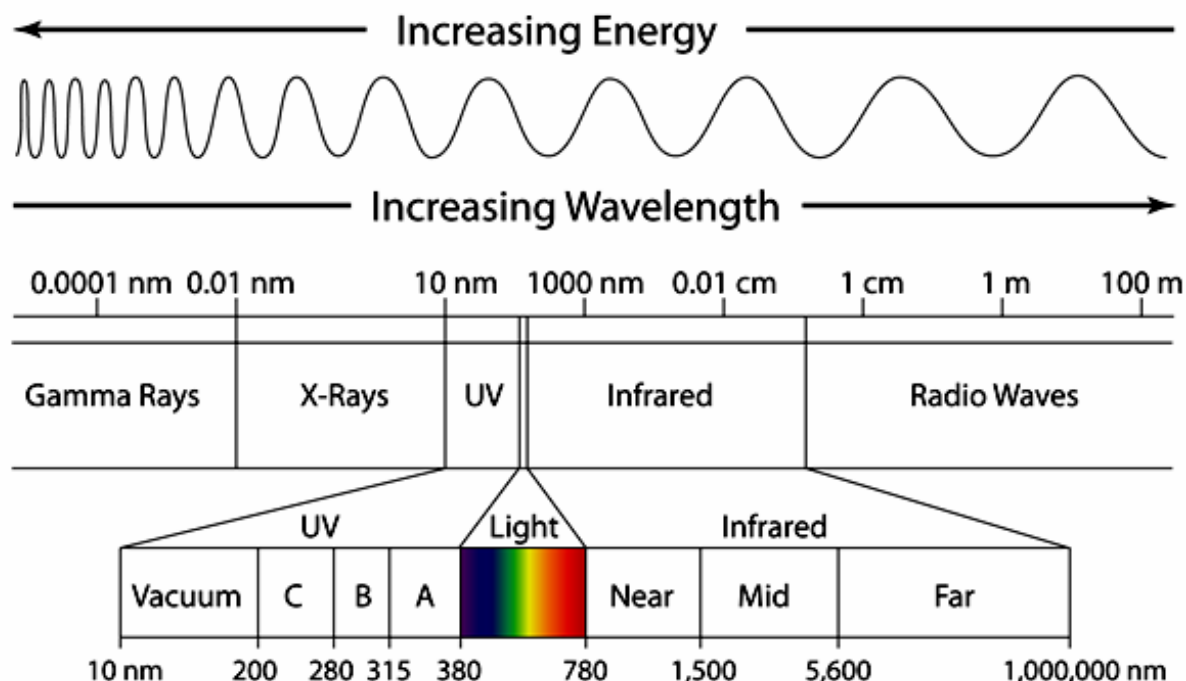

Fig. 9.1. The electromagnetic spectrum

The spectrum is smoothly continuous and the labelling and assignment of separate ranges are largely a matter of convenience. It is important to note that all natural radiation is a form of energy and that energy is inversely proportional to wavelength: the shorter the wavelength the higher the energy.

All electromagnetic radiation travels at a fixed speed of 3×10^{10} cm per sec which is the speed of light, c , in a vacuum. The distance between two peaks along the line of travel is the wavelength, λ , and the number of peaks passing a point in unit time is the frequency, ν , usually expressed in cycles per second (hertz) (Fig. 9.2).

The arithmetic relationship of these three quantities is expressed by:

$$c = \lambda \cdot \nu.$$

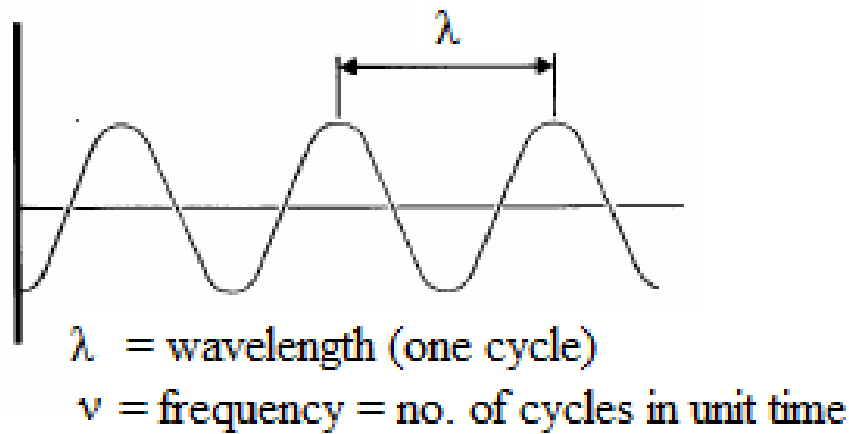

Fig. 9.2. Wavelength and frequency

The laws of quantum mechanics may be applied to photons to show that:

$$E = h \cdot \nu,$$

where E is the energy of the radiation;
 ν – the frequency and h is Planck's constant.

Combining these two equations:

$$E = h \cdot c / \lambda.$$

In the visible region it is convenient to define wavelength in nanometres (nm), that is in units of 10^{-9} meters. The visible spectrum is usually considered to be 380–770 nm and the ultra-violet region is normally defined as 200–380 nm.

Radiation and the atom. Although it is convenient to describe electromagnetic radiation in terms of waves, it is necessary to define another model in order to demonstrate clearly the interactions that lead to selective absorption by an atom or molecule. A determining factor is the energy level of the radiation and it is therefore helpful to consider radiation as discrete packages of energy, or quanta. A quantum of light is known as a photon.

The absorption process depends upon an atomic structure in which each of the electrons of an atom has an energy level associated with its position in the atom. Permitted energy levels are finite and well defined, but an electron may be made to change

to another level if a quantum of energy is delivered equal to the energy difference between the two levels. The original level is called the ground state and the induced level is known as the excited state. Excited states are generally unstable and the electron will rapidly revert to the ground state, losing the acquired energy in the process.

Whilst the accepted model of atomic and molecular structure has arisen from the wave mechanical treatment of Schrodinger, it is convenient to employ an earlier model (that of Bohr) in order to explain more simply the electronic phenomena of interest in spectrophotometry.

The Bohr model defines an atom as having a number of electron shells, $n_1 - n_2 - n_3$ etc, in which the increasing values of n represent higher energy levels and greater distance from the nucleus. Electrons rotate about the nucleus in orbits that may be characterised by the space they occupy and are designated s , p , d , etc according to their geometry. An atom may contain several electrons in multiple orbits in each shell (or each n level) but no orbit may contain more than two electrons (Fig. 9.3).

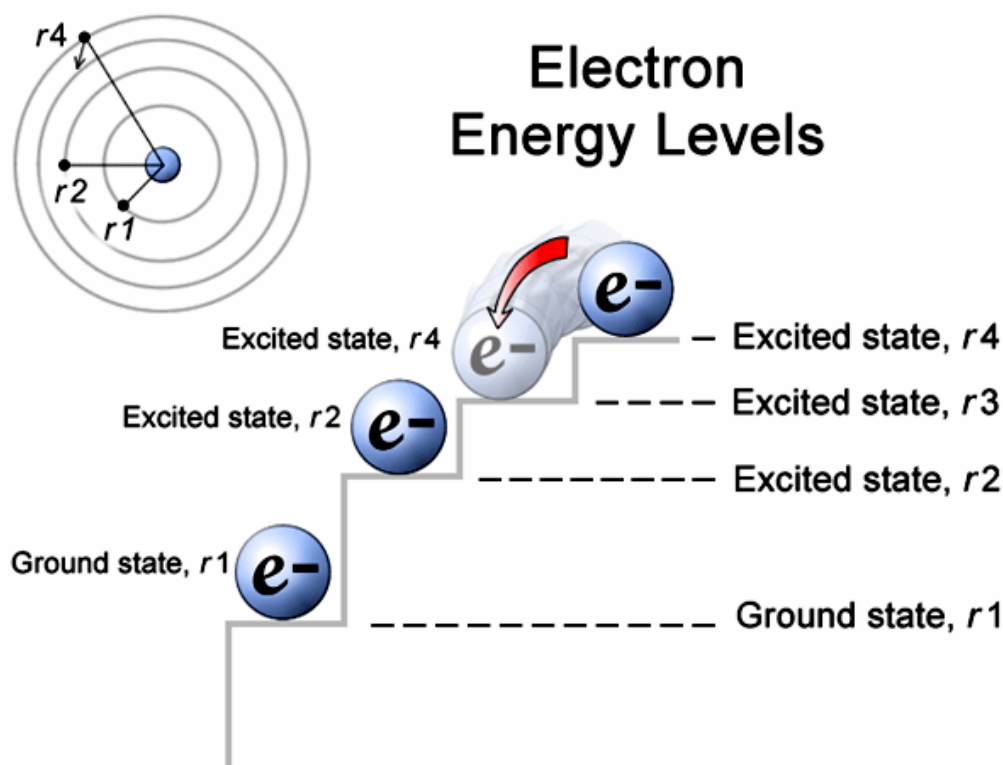
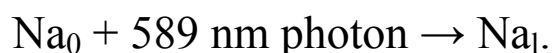

Fig. 9.3. Simplified electron energy levels in an atom

No two electrons can have identical energies but all can be assigned to groups corresponding to the shells, each of which has a clearly differentiated energy level. The effect of subjecting an atom to appropriate radiation is well demonstrated by considering atoms of sodium vapour.

A sodium atom at ground state (Na_0) will absorb a photon at 589 nm to cause a transition of an electron in the outermost shell to a higher energy orbital:



The same ground state atom will also absorb a 330 nm photon to promote a transition to its second excited state:

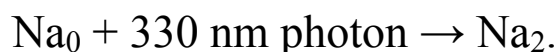

The diagram illustrates the higher energy required to cause a second level transition, corresponding with the higher energy (shorter wavelength) of the radiation that stimulates the transition (Fig. 9.4).

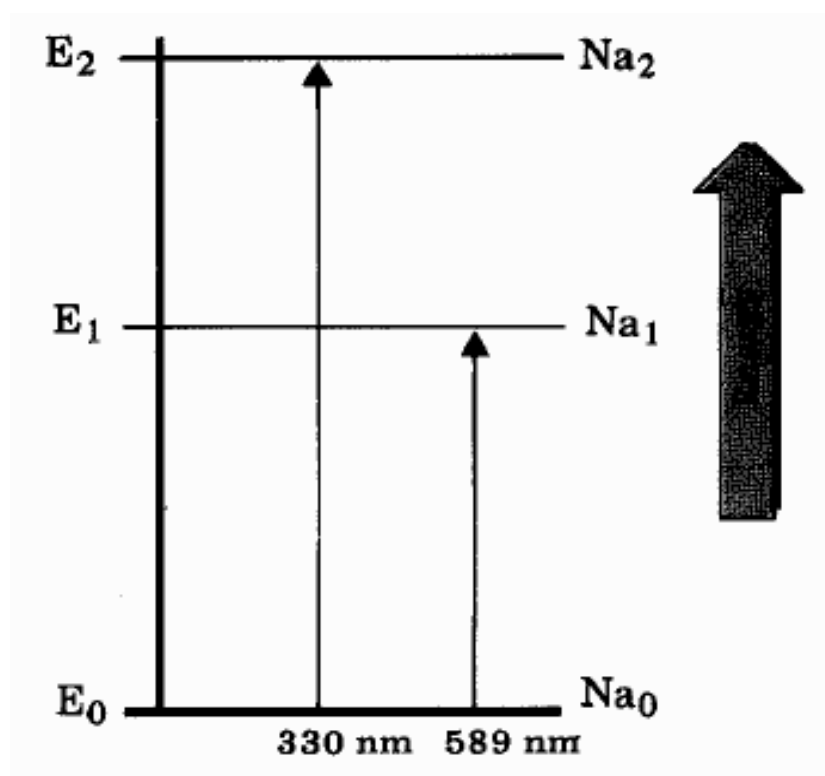

Fig. 9.4. Absorption by gaseous atomic sodium

Radiation and the molecule. Electrons in the atom can be considered as occupying groups of roughly similar energy levels. In the more complicated molecular model, electrons associated with more than one nucleus, the so-called bonding electrons, are particularly susceptible to energy level transitions under the stimulus of appropriate radiation.

The electrons concerned, usually p type electrons in the first or second shell, may be present in one of two conditions: σ (sigma) in localized bonds with a low probability of transitions (and therefore of absorption) or π (pi) where the transition probability is much higher. The presence of a carbon-carbon double bond in the molecule increases the likelihood of π type bonds, especially when conjugated double bonds are involved, i.e. double bonds that alternate with single bonds. The effect is still greater in the presence of nitrogen.

Chemical bonds are formed by overlapping atomic orbitals that result in molecular orbitals of one of three types: bonding (low energy), antibonding (high energy), or non-bonding. Energy absorption is most typically associated with transitions induced in electrons involved in bonding orbitals, and the atoms involved are, for the most part, those containing s + p electrons. Two types of bond must be mentioned:

- 1) σ bond with its related antibonding orbital designated σ^* ;
- 2) π bonds with the corresponding π^* antibonding orbital.

The uninvolved n (non-bonding) electrons have no antibonding orbital.

The full series of permitted electronic transitions (by UV/Vis absorption) is presented in Fig. 9.5.

The Fig. 9.5 shows that $\sigma \rightarrow \sigma^*$ and $n \rightarrow \sigma^*$ transitions require relatively high energy and are therefore associated with shorter wavelength radiation (ultraviolet). Lower energy $n \rightarrow \pi^*$ and $\pi \rightarrow \pi^*$ are ultraviolet or visible induced transitions.

The probability that transition (and therefore absorption) will occur is closely related to molecular orbital structure. If the configuration of the molecular orbitals is accurately known, the probability can be calculated with some certainty and an estimate can be made of the energy intensity (relative to other transitions), indicating an approximate value for the molar absorptivity of the species.

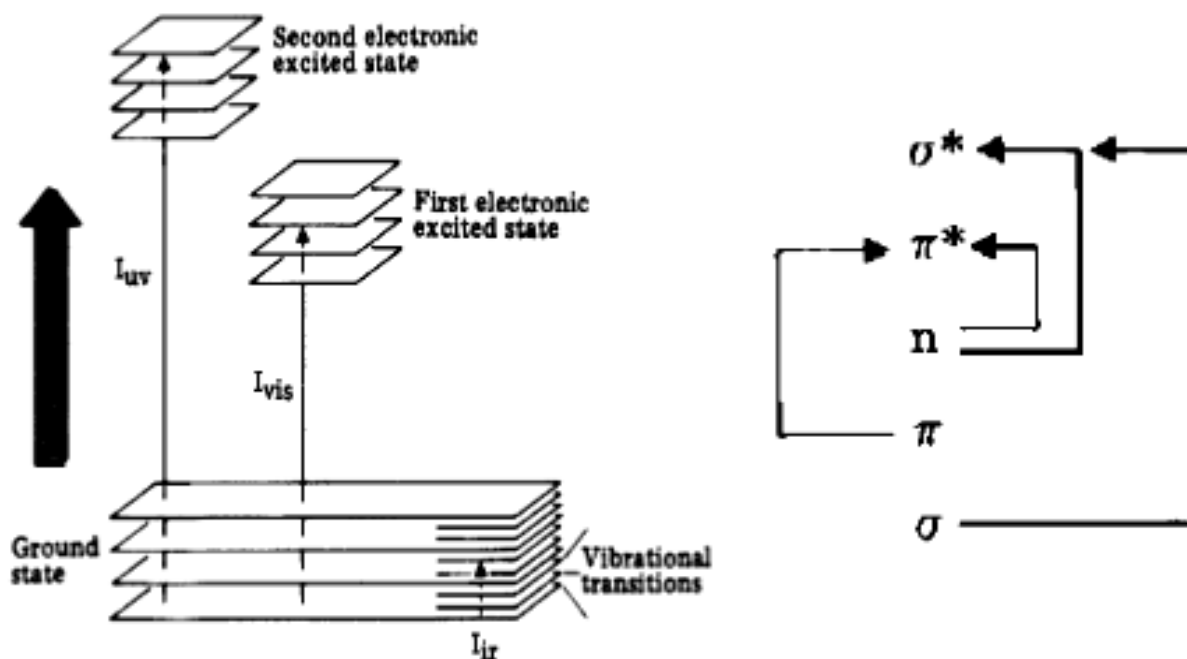

Fig 9.5. The full series of permitted electronic transitions by UV/Vis absorption

Whenever two double bonds are conjugated (i.e. alternate with single bonds), one of the bonding orbitals is raised in energy and the other lowered relative to the energy of an isolated double bond. The same applies to the antibonding orbitals. As a result, transition probability is enhanced, the wavelength of maximum absorption moves to a longer wavelength and the intensity of absorption is frequently increased.

Vibration and rotation. The internal structure of a molecule may respond to radiant energy by more than just electronic transitions. In some molecules the bonding electrons also have natural resonant frequencies that give rise to molecular *vibration* while others exhibit a phenomenon known as *rotation*. Because the differences in energy levels associated with vibration and rotation are much smaller than those involved in electronic transitions, excitation will occur at correspondingly longer wavelengths.

Vibrational absorption is typically associated with the infrared region while the differences between energy levels related to molecular rotation are so small that far infrared or even microwave wavelengths are effective (Fig. 9.6).

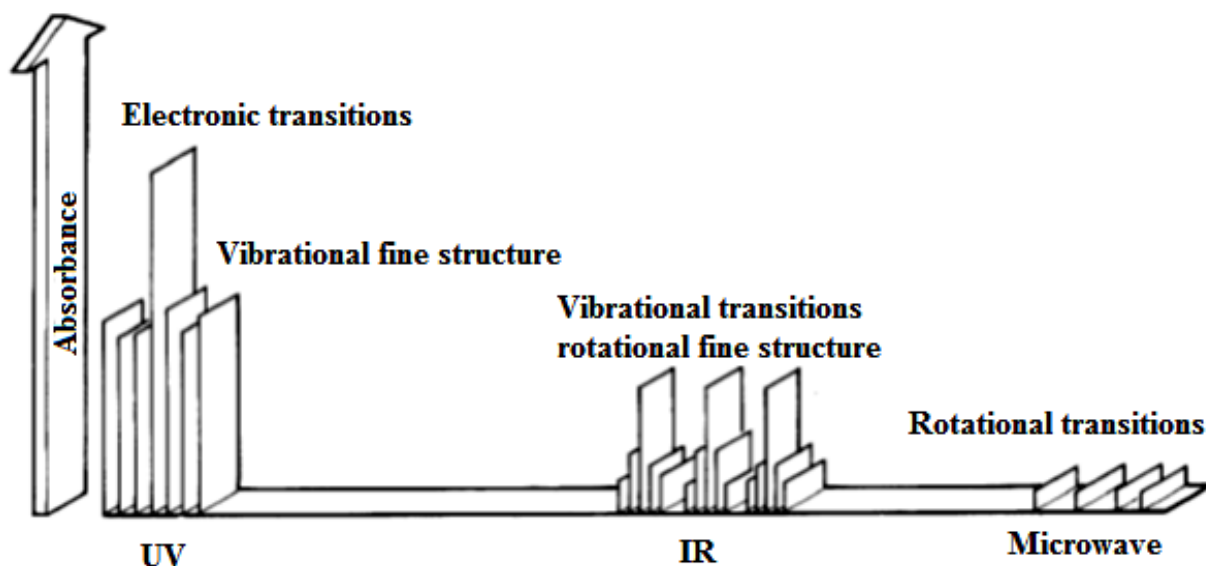

Fig. 9.6. Relationship of wavelength and energy-induced transitions

Specific absorption. Because each electron in a molecule has a unique ground state energy, and because the discrete levels to which it may jump are also unique, it follows that there will be a finite and predictable set of transitions possible for the electrons of a given molecule. Each of the transitions, or jumps, requires the absorption of a quantum of energy and if that energy is derived from electromagnetic radiation there will be a direct and permanent relationship between the wavelength of the radiation and the particular transition that it stimulates. That relationship is known as specific absorption and a plot of those points along the wavelength scale at which a given substance shows absorption «peaks», or maxima, is called an absorption spectrum (Fig. 9.7).

The absorption spectrum of a compound is one of its most useful physical characteristics, both as a means of identification (qualitative analysis) and of estimation (quantitative analysis). If there is absorption in the visible and that absorption occurs in the red then the substance will be seen as green/blue since red and green/blue are complementary colours (Fig. 9.8).

The chemical group most strongly influencing molecular absorption characteristics is called a chromophore. Chromophores which can be detected by UV/Vis spectrophotometers always involve a multiple bond (such as $C = C$, $C = O$ or $C \equiv N$) and may be conjugated with other groups to form complex chromophores.

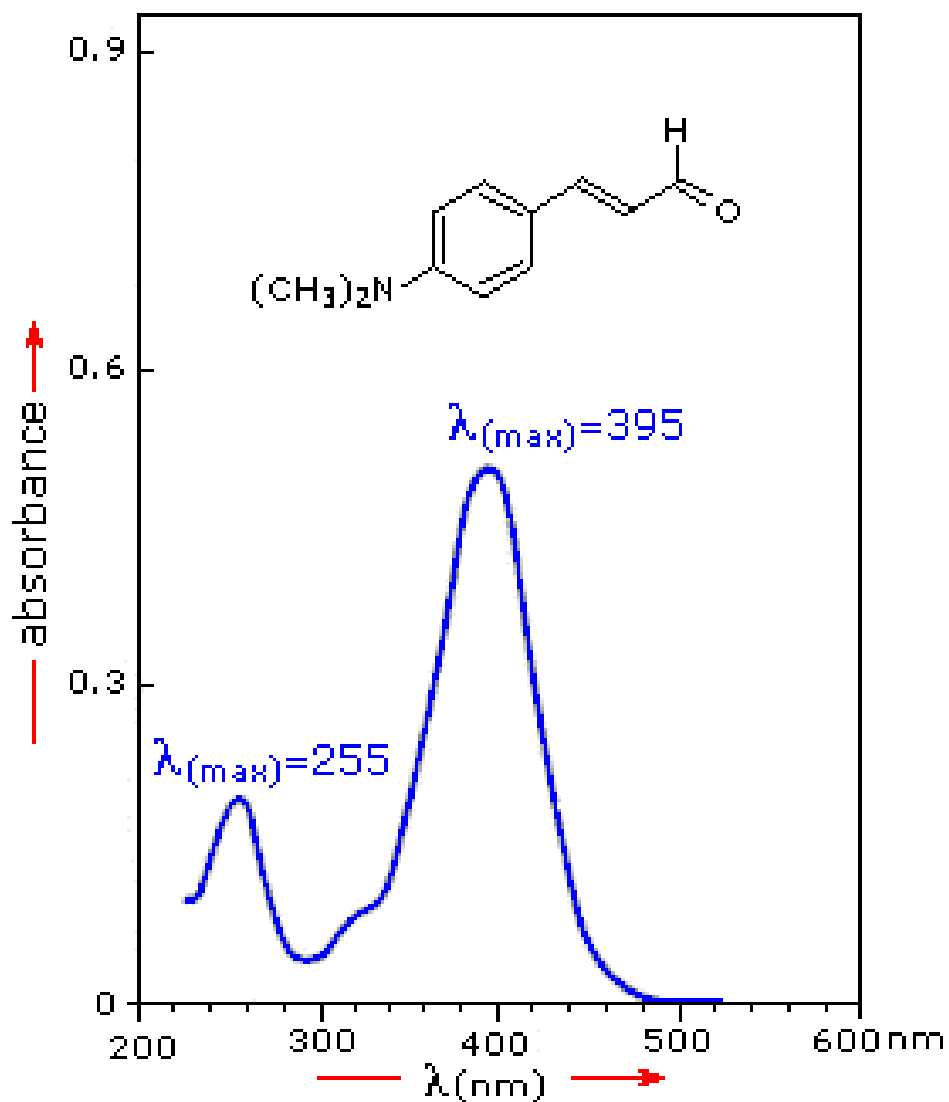

Fig. 9.7. Typical absorption spectrum in UV/visible region

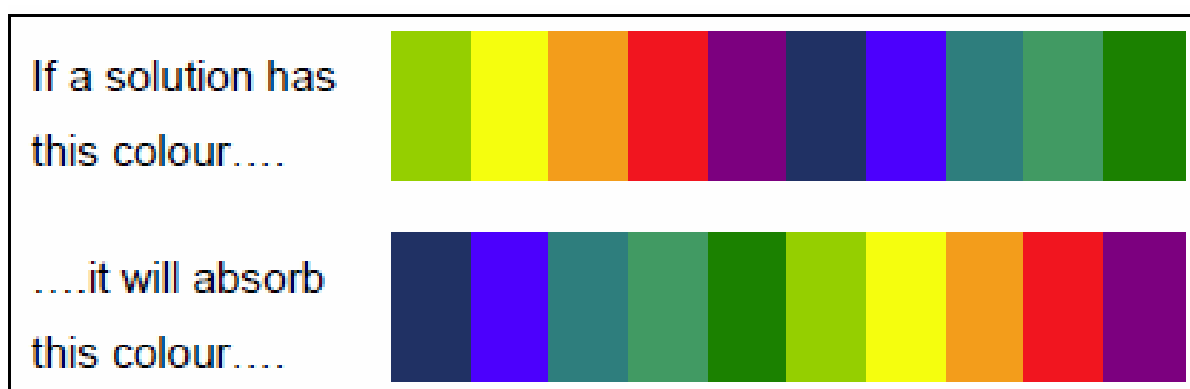

Fig. 9.8. Complementary colors

A typical example is the benzene ring which has an absorption peak at 254 nm. Increasingly complex chromophores move

the associated absorption peak towards longer wavelengths and generally increase the absorption at the maxima.

An **auxochrome** (gr. auxanein – to increase, chroma – colour) is a group of atoms attached to a chromophore which modifies the ability of that chromophore to absorb light. They themselves fail to produce the colour; but when present along with the chromophores in an organic compound intensifies the colour of the chromogen. Examples include the hydroxyl group (-OH), the amino group (-NH₂), and an aldehyde group (-CHO). An auxochrome is a functional group of atoms with nonbonded electrons which, when attached to a chromophore, alters both the wavelength and intensity of absorption. If these groups are in direct conjugation with the pi-system of the chromophore, they may increase the wavelength at which the light is absorbed and as a result intensify the absorption. A feature of these auxo-chromes is the presence of at least one lone pair of electrons which can be viewed as extending the conjugated system by resonance.

There are two phenomena seen in *molecular* spectra – hypsochromic and bathochromic shifts. Hypsochromic shift – a shift of a spectral band to shorter wavelengths as a result of substitution in a molecule or as a result of a change in the physical conditions (e.g. a change in solvent polarity). Bathochromic shift – a shift of a spectral band to longer wavelengths as a result of substitution in a molecule or a change in the conditions.

Although the emphasis on the value of UV/Vis spectrophotometry is naturally towards organic compounds, there is a wide range of inorganic substances that lend themselves to similar methods of analysis. Species with a non-metal atom double bonded to oxygen absorb in the ultraviolet region, and there are several inorganic double-bond chromophores that show characteristic absorption peaks. In some instances, measurement of inorganic materials may demand a secondary process, such as complexation with a color-forming reagent or oxidation – e.g. manganese (II) oxidized to manganese (VII) and measured as the MnO₄⁻ ion (permanganate).

Absorption and concentration. Fig. 9.9 shows the absorption of radiation by a solution containing absorbing compound.

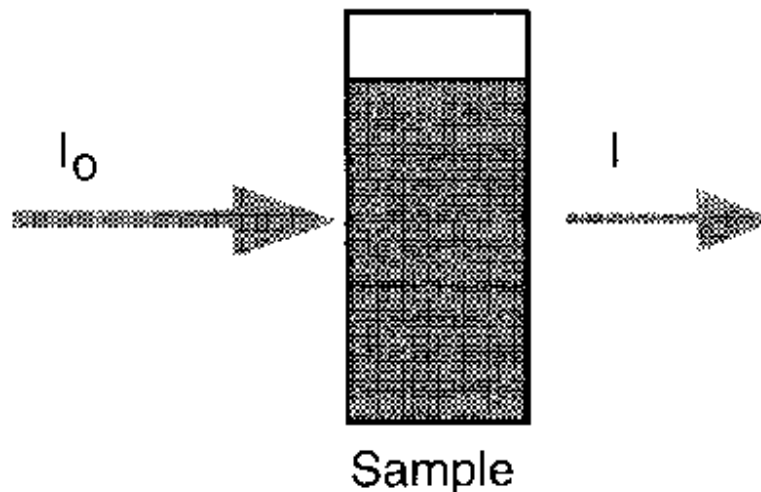

Fig. 9.9. Absorption of light by a solution

For analytical purposes, two main propositions define the laws of light absorption.

1. **Lambert's Law.** The proportion of incident light absorbed by a transparent medium is independent of the intensity of the light (provided that there is no other physical or chemical change to the medium). Therefore successive layers of equal thickness will transmit an equal proportion of the incident energy. Lambert's law is expressed by

$$I/I_0 = T,$$

where I is the intensity of the transmitted light;
 I_0 – the intensity of the incident light;
 T – the Transmittance.

It is customary to express transmittance as a percentage:

$$\%T = I / I_0 \cdot 100.$$

2. **Beer's Law.** The absorption of light is directly proportional to both the concentration of the absorbing medium and the thickness of the medium in the light path.

A combination of the two laws (known jointly as the *Beer-Lambert Law*) defines the relationship between absorbance (A) and transmittance (T):

$$A = \log I_0/I = \log 1/T = -\log T = \varepsilon \cdot C \cdot l,$$

where A is absorbance (no unit of measurement);

ε – molar absorptivity ($\text{dm}^3 \text{mol}^{-1} \text{cm}^{-1}$);

C – molar concentration (mol dm^{-3});

l – path length (cm).

In pharmaceutical products, concentrations and amounts are usually expressed in grams or milligrams rather than in moles and thus for the purposes of the analysis of these products, the Beer-Lambert equation is written in the following form:

$$A = E_{1\text{cm}}^{1\%} \times C \cdot l,$$

where A is measured absorbance;

$E_{1\text{cm}}^{1\%}$ is the absorbance of a 1% w/v (1g/100 ml) solution in a 1 cm cell;

l is the pathlength in cm (usually 1 cm);

C is the concentration of the sample in g/100 ml. Since measurements are usually made in 1 cm cell the equation can be written:

$$C = A / E_{\text{cm}}^{1\%},$$

which gives the concentration of the analyte in g/100 ml.

BP monographs often quote a standard $E_{1\text{cm}}^{1\%}$ value for a drug which is to be used in its quantitation.

Instrumentation. The minimum requirements of an instrument to study absorption spectra (a spectrophotometer) are shown below (Fig. 9.10) and include:

- 1) a source of radiation of appropriate wavelengths;
- 2) a means of isolating light of a single wavelength and getting it to the sample compartment – monochromator and optical geometry;
- 3) a means of introducing the test sample into the light beam – sample handling;
- 4) a means of detecting and measuring the light intensity.

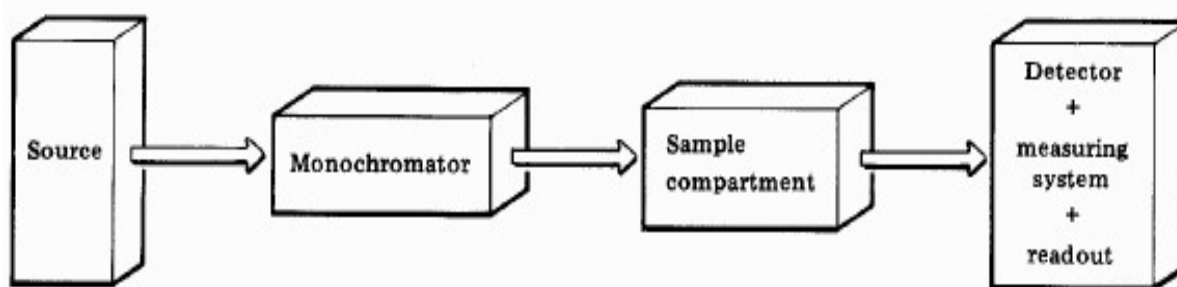

Fig. 9.10. **Basic construction of a spectrophotometer**

Source. The requirements are that the source should be stable during the measurement period, i.e. that the intensity of emitted radiation should not fluctuate, and that there should be adequate intensity over as large a wavelength region as possible.

Ultraviolet light is generally derived from a deuterium arc that provides emission of high intensity and adequate continuity in the 190–380 nm range. A quartz or silica envelope is necessary not only because of the heat generated but also to transmit the shorter wavelengths of the ultraviolet radiation. The limiting factor is normally the lower limit of atmospheric transmission at about 190 nm (Fig. 9.11).

Visible light is normally supplied by a tungsten lamp or, in modern systems, by a tungsten-halogen (also described as quartz-iodine) lamp which has higher relative output in the cross-over region (320–380 nm). The long wavelength limit is usually the cut-off of the glass or quartz envelope, normally well beyond the useful visible limit at 900 nm (Fig. 9.11).

In most modern spectrophotometers the power supply arrangements, including any necessary start-up sequences for arc lamps, as well as the cross-over between sources at the appropriate wavelength, are automatic mechanical sequences. Lamps are usually supplied on pre-set focus mounts or incorporate simple adjustment mechanisms for easy replacement. Recently, xenon lamp sources have been introduced, and these cover the UV and visible range. There is a trade off, however, because the instrumental stray light is higher and there is less energy at the far visible end.

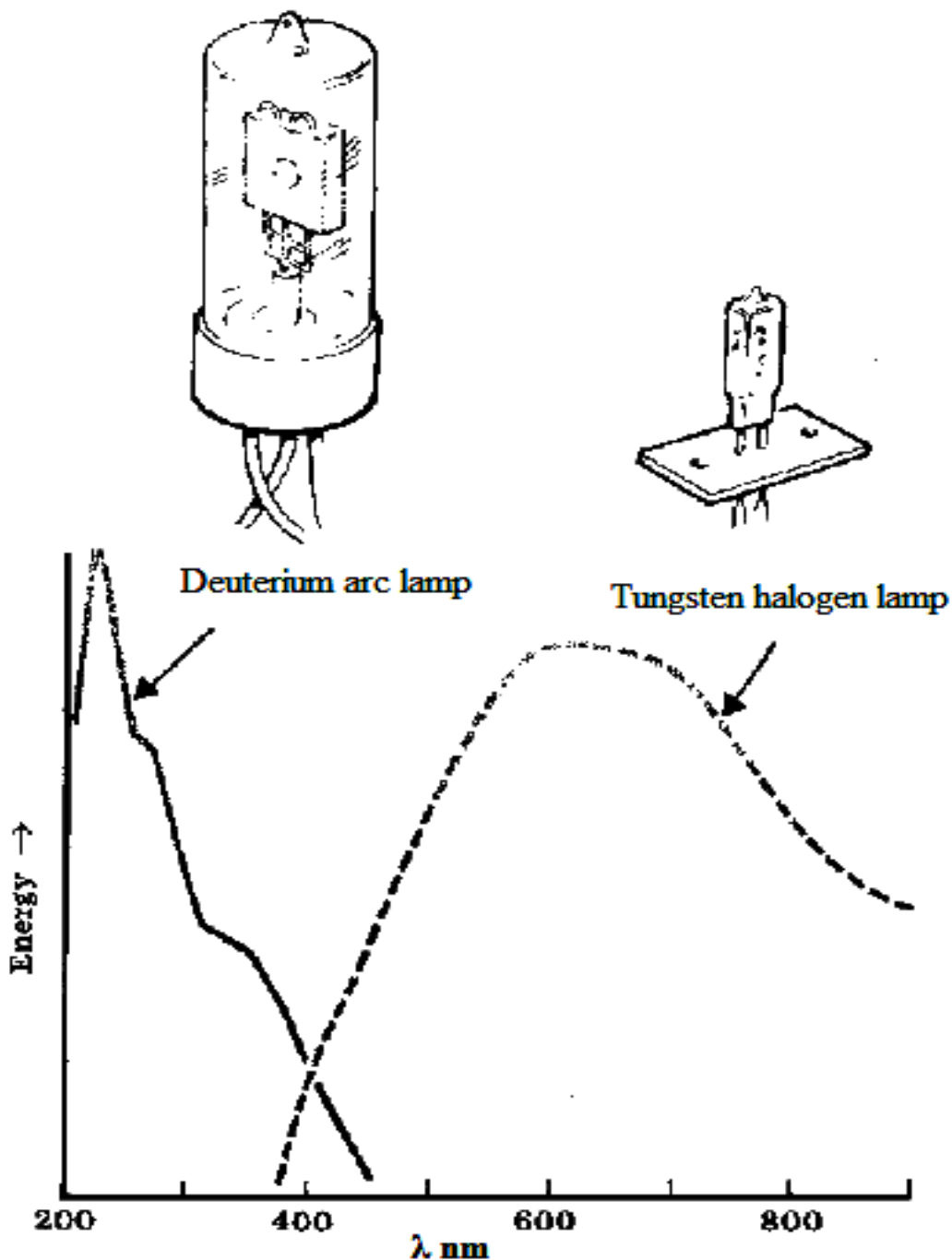

Fig. 9.11. UV/Vis light sources

For general measurements, however, they are ideal and have the benefit of a long lifetime as they are only consumed during the actual measurement cycle («press to read»). In addition, no cross-over wavelength is necessary.

Monochromator. The function of a monochromator is to produce a beam of monochromatic (single wavelength) radiation that can be selected from a wide range of wavelengths. The essential components are entrance slit, collimating device (to pro-

duce parallel light), a wavelength selection or dispersing system, a focusing lens or mirror and an exit slit.

Two basic methods of wavelength selection may be noted, filters and a dispersing system (e.g. a prism or diffraction grating).

Filters of colored glass or gelatine are the simplest form of selection, but they are severely limited in usefulness because they are restricted to the visible region and they have wide spectral bandwidths (typical bandwidths are rarely better than 30–40 nm).

A prism of suitable material and geometry will provide a continuous spectrum in which the component wavelengths are separated in space. After dispersion the spectrum is focused at the exit slit which may be scanned across the beam to isolate the required wavelength. Prism monochromators with bandwidths in the UV/Vis of 1 nm or better are achieved without great difficulty and so performance is greatly improved compared with filter-based designs. However, there are drawbacks associated with using prisms: their non-linear dispersion, the temperature related characteristics of the commonly used prism materials and the complicated prism drive mechanism necessary to provide a convenient wavelength control and readout.

Diffraction gratings provide an alternative means of producing monochromatic light. A diffraction grating consists of a series of parallel grooves (lines) on a reflecting surface that is produced by taking a replica from a master carefully prepared using a machine or, increasingly, from one which is holographically generated. The grooves can be considered as separate mirrors from which the reflected light interacts with light reflected from neighbouring grooves to produce interference, and so to select preferentially the wavelength that is reflected when the angle of the grating to the incident beam is changed. Among the advantages that gratings offer (compared to prisms) are better resolution, linear dispersion and therefore constant bandwidth and simpler mechanical design for wavelength selection.

Optical geometry. As all absorption measurements are ratio dependent (I/I_0), it is necessary to record a reference solution be-

fore bringing the sample under test into the light path. These measurements are done using a cuvette (matched, if possible, to that containing the test sample) in the light path filled with the appropriate solvent. The reference intensity (I_0) varies with wavelength in a complicated multi-function way (due mainly to source energy, monochromator transmission, slit width and detector response), so it is essential, when measuring absorption, to re-measure the reference for each discrete wavelength at which measurement is to be made. All modern instruments are micro-processor based, and have the facility to store a baseline, that is 100% T or 0 A set at each wavelength in the range, overcoming this requirement. This has allowed single beam spectrophotometers to compete on performance with the more expensive double beam instruments.

Traditionally, the preferred technique was a double-beam geometry in the sample handling area (Fig. 9.12).

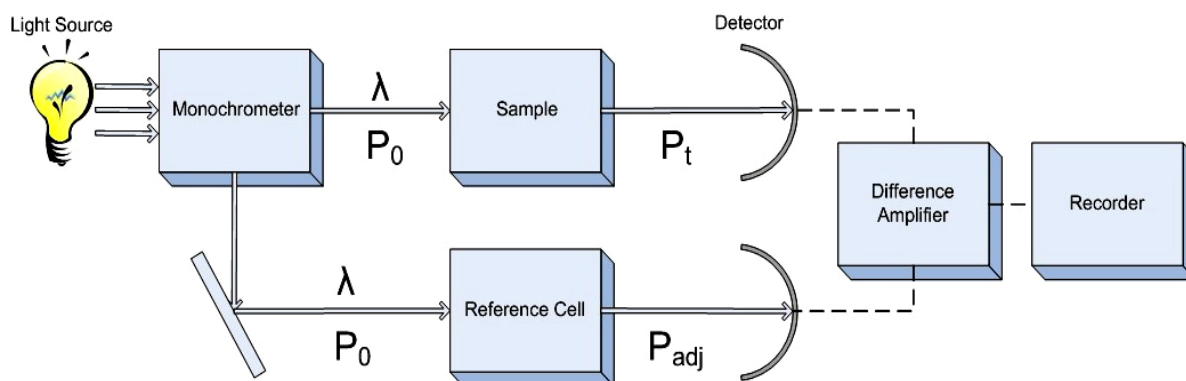

Fig. 9.12. **Typical double beam optics in sample area**

Double-beam operation is achieved by a time-sharing system in which the light path is directed (by rotating sectional mirror or similar device) alternately through the sample and the reference cell. The wavelength dependent functions of the instrument are significantly reduced to give much improved operating characteristics by a feedback system in the reference channel that adjusts the detector gain to compensate for source and detector variations. To make full use of the potential of double beam operation it is usual to add wavelength scanning and some form of output recording: UV/Vis spectrophotometers of this

type will, after initiation, produce automatically an absorption spectrum.

The development of the microprocessor has made it possible to achieve excellent results using a single beam configuration when compared to a double beam configuration; this results in greater optical and mechanical simplicity. The process of comparison between reference and sample cells can be achieved with single beam instrumentation by feeding the post detector signal to a microprocessor which stores the reference data for subtraction from the sample signal prior to printing or displaying the reference corrected result (the baseline). Signal levels can be compared between different samples at one wavelength, at a series of predetermined wavelengths or, if wavelength drive is provided, a complete absorption spectrum can be obtained.

Sample handling. In practice, by far the greater part of all measurements will be made on samples in solution. Vapours and solids can be accommodated, but most instruments are designed with a standard cell (or cuvette) as the normal sample container. The design, construction and material of the cuvette are all important to accurate measurements as are operator practice and sample preparation.

Cuvettes are typically made of glass or UV grade silica (according to the wavelength range of interest), are fused rather than cemented (to resist the action of some solvents), and have the following characteristics:

- optical windows (the sides through which the beam passes) are highly polished, parallel and flat;
- entrance and exit surfaces are exactly parallel and orthogonal;
- light path (distance between inner surfaces of windows) is tightly controlled.

The holder that locates the cuvette in the light beam must ensure precise and reproducible location with respect to the beam.

The most commonly used cuvette has a light pathlength of 10 mm, but longer or shorter pathlengths are useful if concentration or absorbance fall outside normal ranges without further

processing – e.g. solvent extraction or dilution. Microcells are particularly useful where sample volumes are restricted: gas cells, flow cells and disposable cells are all available to extend the usefulness of the technique. A range of sample cuvettes is shown in Fig. 9.13.

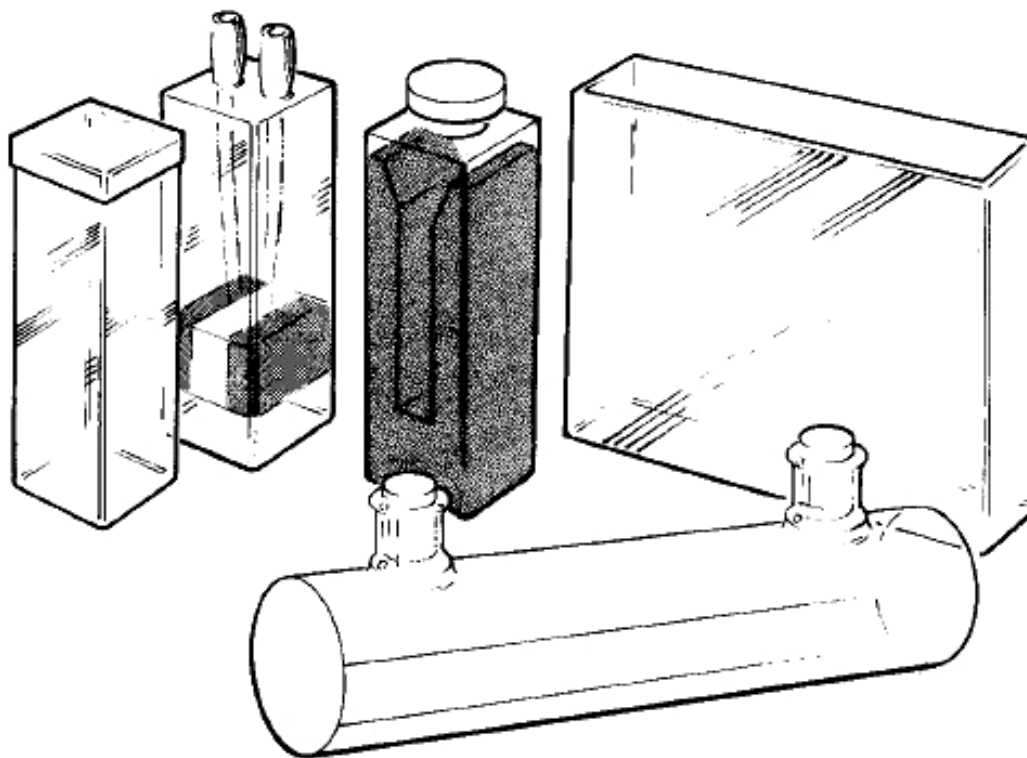

Fig. 9.13. Selection of sample cuvettes

Detectors. Of the four principal types of detectors found in spectrophotometers one, the photoconductive cell (typically a light sensitive layer, e.g. selenium, on a metal substrate) is so severely restricted in both wavelength response and sensitivity, that it is almost never found in instruments of the class under consideration. The most commonly encountered detectors are the photomultiplier, the silicon diode and the diode array.

Measuring Systems. The primary function of a spectrophotometer ends with the provision of a signal (normally an electrical voltage) that is proportional to the absorption by a sample at a given wavelength. The signal handling and measuring systems can be as simple as an amplifier and a meter or as elaborate as a personal computer and printer, depending on the application.

Topic 10

Infrared (IR) spectroscopy for medicines quality control

Objective: To learn the theoretical and practical foundations of infrared spectroscopy. Get the basic concepts of near infrared spectroscopy.

Infrared spectroscopy is a technique based on the vibrations of the atoms of a molecule. An infrared spectrum is commonly obtained by passing infrared radiation through a sample and determining what fraction of the incident radiation is absorbed at a particular energy. The energy at which any peak in an absorption spectrum appears corresponds to the frequency of a vibration of a part of a sample molecule.

Infrared spectroscopy is certainly one of the most important analytical techniques available to today's scientists. One of the great advantages of infrared spectroscopy is that virtually any sample in virtually any state may be studied. Liquids, solutions, pastes, powders, films, fibres, gases and surfaces can all be examined with a judicious choice of sampling technique.

The term «infrared» covers the range of the electromagnetic spectrum between 0,78 and 1000 μm (Fig. 9.1). It is suitable to divide the infrared region into three sections; *near*, *mid* and *far* infrared (Table 10.1). The most useful for chemical structure determination is the middle IR region, which lies between 4000–670 cm^{-1} .

Table 10.1

Subdivisions of infrared region

Region	Wavelength range (μm)	Wavenumber range (cm^{-1})
Near	0,78–2,5	12 800–4000
Middle	2,5–50	4000–200
Far	50–1000	200–10

In the context of infrared spectroscopy, wavelength is measured in «wavenumbers», which have the units cm^{-1} . Wavenumber is defined like this:

$$\text{wavenumber} = 1/\lambda.$$

Energy of a molecule consists of translational, rotational, vibrational and electronic energy. Translation energy of a molecule is associated with the movement of the molecule as a whole, for example in a gas. Rotational energy is related to the rotation of the molecule, whereas vibrational energy is associated with the vibration of atoms within the molecule. Finally, electronic energy is related to the energy of the molecule's electrons.

Like radiant energy, the energy of a molecule is quantized too and a molecule can exist only in certain discrete energy levels. Within an electronic energy level a molecule has many possible vibrational energy levels. To raise the electronic energy state of a molecule from the ground state to the excited state will cost more energy than to raise the vibrational energy state. A simplified representation of the quantized electronic and vibrational energy levels of a molecule can be found in Fig. 10.1.



Fig. 10.1. A schematic representation of the quantized electronic and vibrational energy levels of a molecule: to raise the electronic energy state of a molecule from the ground state to the excited state will cost more energy than to raise the vibrational energy state

The vibrational energy of a molecule is not determined by the orbit of an electron but by the shape of the molecule and the masses of the atoms. The forces that hold the molecule together are assumed to be similar to those exerted by massless springs. Each mass requires three coordinates to define its position, such as x , y and z in a Cartesian coordinate system. As a result it has three independent degrees of freedom of motion. If there are N atomic nuclei in the molecule, there will be a total of $3N$ degrees of freedom of motion for all the nuclear masses in the molecule.

After subtracting the translational and rotational degrees of freedom from the total $3N$ degrees of freedom, we are left with $3N - 6$ internal degrees of freedom for a nonlinear molecule and $3N - 5$ internal degrees of freedom for a linear molecule.

These are the so-called normal modes of vibrations and they result in specific natural vibrational frequencies for different molecular configurations. The typical frequencies of these vibrations match the frequency of IR radiation.

Interaction of light and molecules. IR radiation does not have enough energy to induce electronic transitions as seen with UV and visible light. Absorption of IR is restricted to excite vibrational and rotational states of a molecule.

Even though the total charge on a molecule is zero, the nature of chemical bonds is such that the positive and negative charges do not necessarily overlap in this case. Such molecules are said to be polar because they possess a permanent dipole moment. For a molecule to absorb IR, the vibrations or rotations within a molecule must cause a net change in the dipole moment of the molecule. The alternating electrical field of the radiation interacts with fluctuations in the dipole moment of the molecule. If the frequency of the radiation matches the vibrational frequency of the molecule then radiation will be absorbed, causing a change in the amplitude of molecular vibration. The result of IR absorption is heating of the matter since it increases molecular vibrational energy (Fig. 10.2).

Molecular vibrations give rise to absorption bands throughout most of the IR region of the spectrum. The far IR, lying adjacent to the microwave region, has low energy and may be used for rotational spectroscopy.

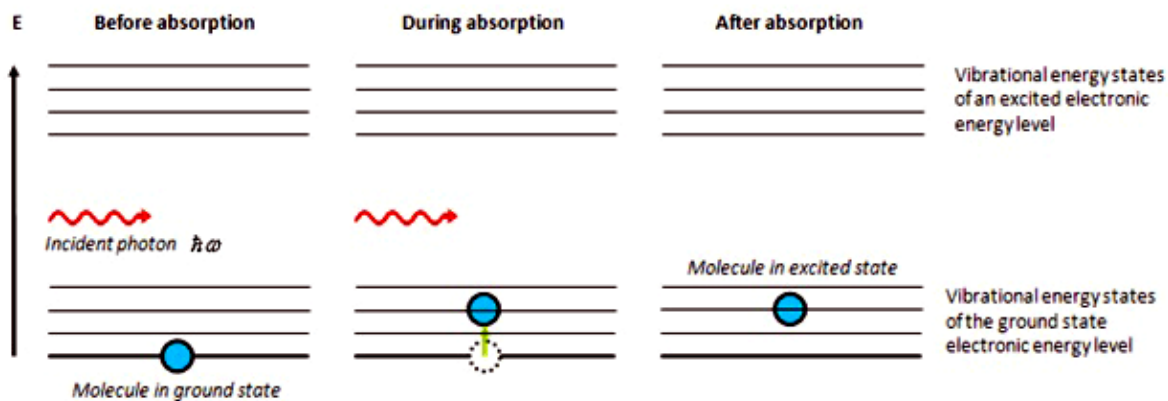

Fig. 10.2. Energy levels of a molecule during the absorption of a photon

Instrumentation. In an IR spectrometer molecules are irradiated with a whole range of IR frequencies but are only capable of absorbing radiation energy at certain specific frequencies which match the vibration frequencies of the molecule.

A spectrometer usually measures the radiation intensity as a function of the wavelength of the light behind a sample. At the vibrational frequencies of the molecules, an intensity decrease is obtained and a transmittance or absorbance spectrum is plotted. In this way a sample can be characterized and allows to determine which chemical bonds are present (Fig. 10.3).

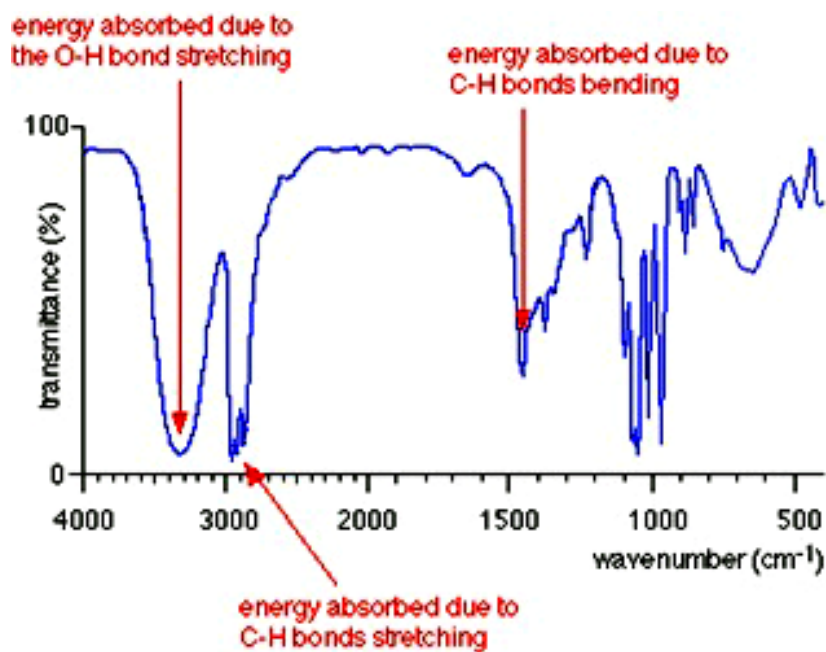

Fig. 10.3. Transmittance infrared spectrum of propan-1-ol, $\text{CH}_3\text{CH}_2\text{CH}_2\text{OH}$

Infrared spectrometers have been commercially available since the 1940s. At that time, the instruments relied on prisms to act as dispersive elements, but by the mid-1950s, diffraction gratings had been introduced into dispersive machines. The most significant advances in infrared spectroscopy, however, have come about as a result of the introduction of Fourier-transform spectrometers. This type of instrument employs an interferometer and exploits the well-established mathematical process of Fourier-transformation. Fourier-transform infrared (FTIR) spectroscopy has dramatically improved the quality of infrared spectra and minimized the time required to obtain data.

Classical method (Fig. 10.4). A beam of IR radiation is produced and split into two separate beams. One is passed through the sample, the other is passed through a reference which is often the solvent.

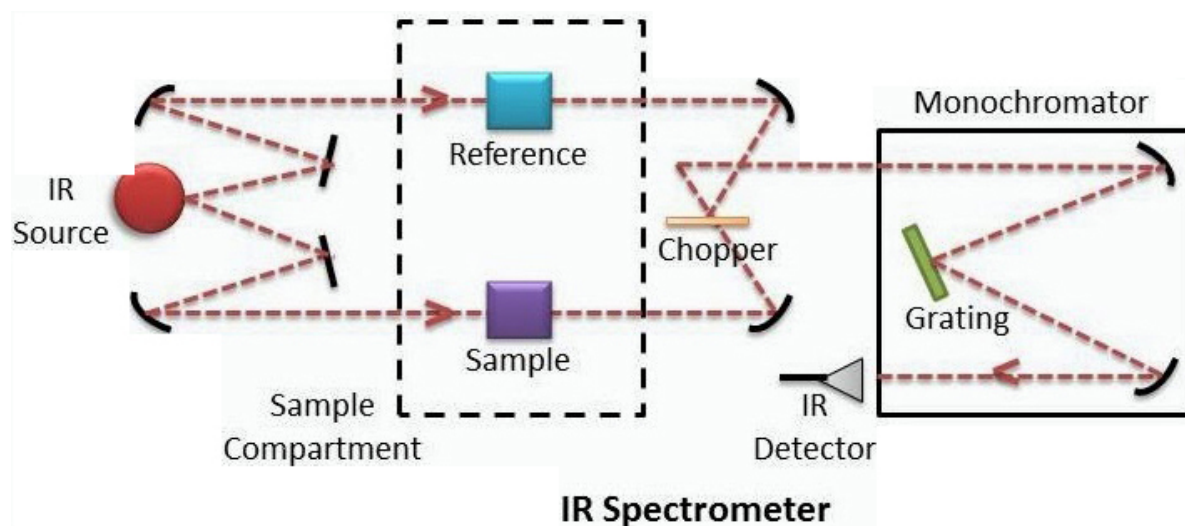

Fig. 10.4. A possible optical layout of a spectrophotometer

The beams pass through a splitter (the section mirror) which quickly alternates which of the two beams enters the monochromator. A monochromator is an optical device that transmits a mechanically selectable narrow band of wavelengths of radiation chosen from a wider range of wavelengths available at the input. The monochromator makes it possible to scan through the spectrum. Finally, the beams are both directed towards a detector. The two signals are then compared and a printout is obtained.

A reference sample is used for two reasons: this prevents fluctuations in the output of the source affecting the data and this allows the effects of the solvent to be cancelled out.

Source. It is difficult to find a perfect source for a spectrophotometer. The most ideal radiation source would be one emitting constant energy over the whole IR region. Unfortunately, as yet such sources have not been developed and so we have to do the best we can with the following ones:

- Nerst filament (ZrO and some other rare earth oxides);
- Globar (Si-C);
- Ni-Cr wire;
- Heated ceramic;
- Mercury lamp.

The main disadvantage of all these sources is the very unequal energy distribution in relation to the wavelength. The energy emission curve for ‘black body radiation’ is as given in Fig. 10.5.

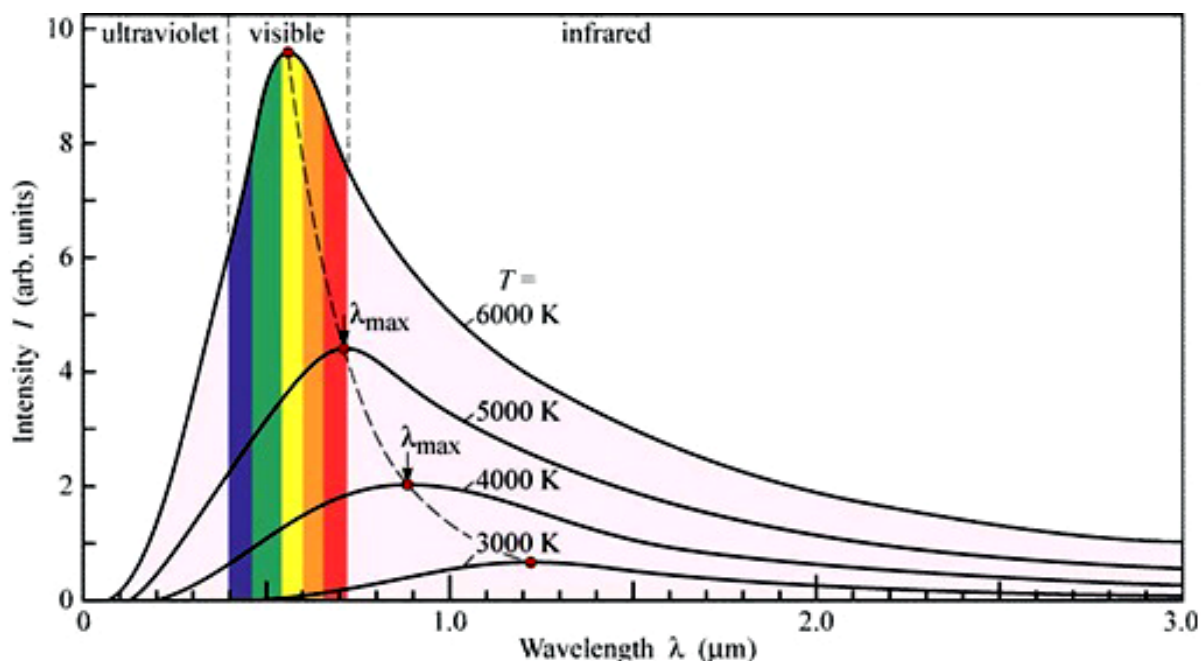

Fig. 10.5. Spectral intensity distribution of Planck's black-body radiation as a function of wavelength for different temperatures

Fourier Transform Infrared (FTIR) spectroscopy. Instead of recording the amount of energy absorbed when the frequency of the IR radiation is varied by a monochromator, the IR radiation is guided through an interferometer. The purpose of

the interferometer is to have a beam of IR radiation, split it into two beams, and make one of the beams travel a different (optical) distance than the other in order to create alternating interference fringes. A diagram of a Michelson interferometer is shown in the Fig. 10.6.

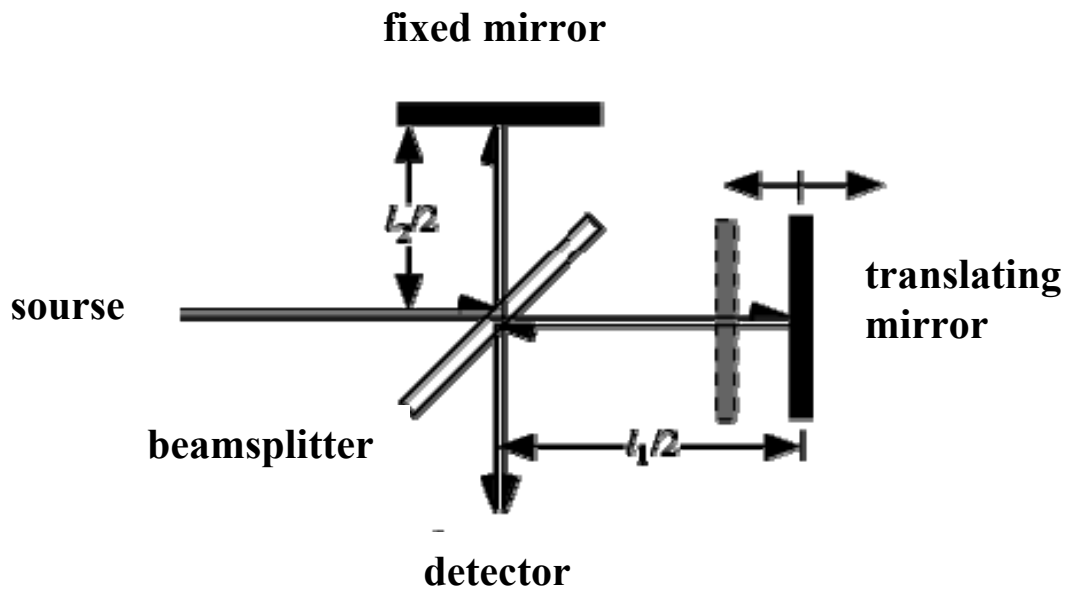

Fig. 10.6. **The Michelson interferometer**

The Michelson interferometer consists of four arms. The first arm contains a source of IR radiation, the second arm contains a stationary mirror, the third arm contains a moving mirror, and the fourth arm is open. At the intersection of the four arms a beamsplitter is placed, which is designed to transmit half the radiation that impinges upon it, and reflect the other half. As a result, the light transmitted by the beamsplitter strikes the fixed mirror, and the light reflected by the beamsplitter strikes the moving mirror. After reflecting off their respective mirrors, the two light beams recombine at the beamsplitter, then leave the interferometer to interact with the sample and strike a detector.

In a Michelson interferometer an optical path difference is introduced between the two beams by translating the moving mirror away from the beamsplitter. A general property of (optical) waves is that their amplitudes are additive. When the beams that have reflected off the fixed and moving mirrors recombine

at the beamsplitter are in phase, an intense beam leaves the interferometer as a result of constructive interference. When the fixed and moving mirrors beams are recombined at the beamsplitter and the waves are completely out of phase, a low intensity beam leaves the interferometer as a result of destructive interference. A plot of light intensity versus optical path difference is called an interferogram. In fact, the interferogram is a measurement of the temporal coherence of the light at each different time delay setting. With the use of Fourier transformations it is possible to convert a signal in the time domain to the frequency domain (i.e. the spectrum). The fundamental measurement obtained by an FTIR is made in the time domain, which is Fourier transformed to give a spectrum (Fig. 10.7). This is where the term Fourier Transform IR spectroscopy comes from.

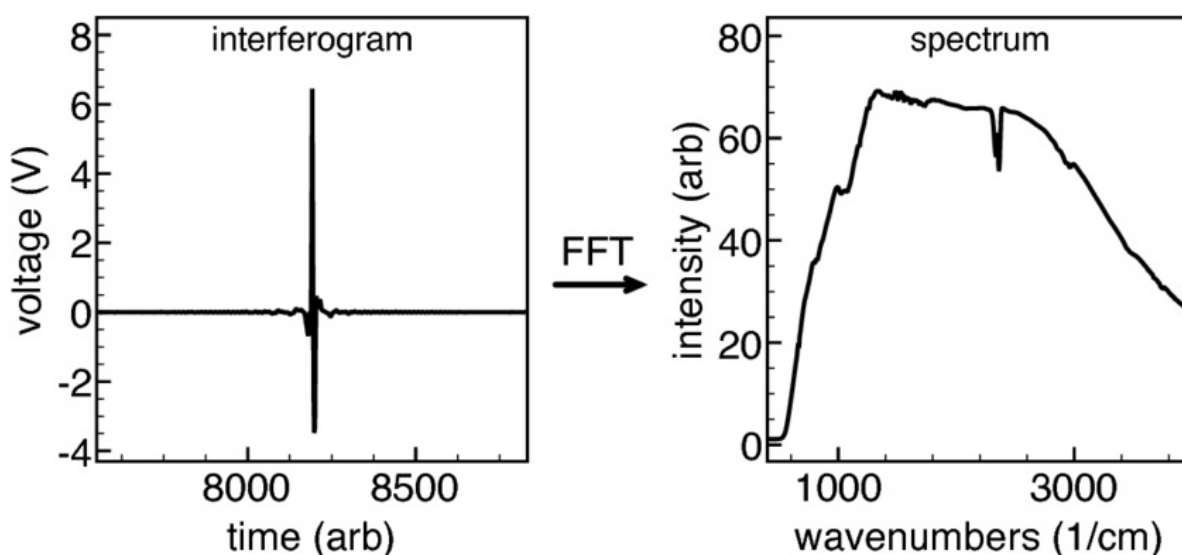

Fig. 10.7. An Interferogram is Fourier transformed to give a spectrum

FTIR spectrometers are cheaper than conventional spectrometers because building of interferometers is easier than the fabrication of a monochromator. In addition, measurement of a single spectrum is faster for the FTIR technique because the information at all frequencies is collected simultaneously. This allows multiple samples to be collected and averaged together resulting in an improvement in sensitivity. Because of its vari-

ous advantages, virtually all modern IR spectrometers are FTIR instruments.

Infrared spectroscopy has been extensively used in both qualitative and quantitative pharmaceutical analysis. This technique is important for the evaluation of the raw materials used in production, the active ingredients and the excipients (the inert ingredients in a drug formulation, e.g. lactose powder, hydroxypropyl cellulose capsules, etc.). Although nuclear magnetic resonance spectroscopy and mass spectrometry are widely used in the pharmaceutical industry for the identification of drug substances, infrared spectroscopy can provide valuable additional structural information, such as the presence of certain functional groups.

An example of IR spectrum analysis. Fig. 10.8 illustrates the diffuse reflectance infrared spectrum of *acetylsalicylic acid* (aspirin).

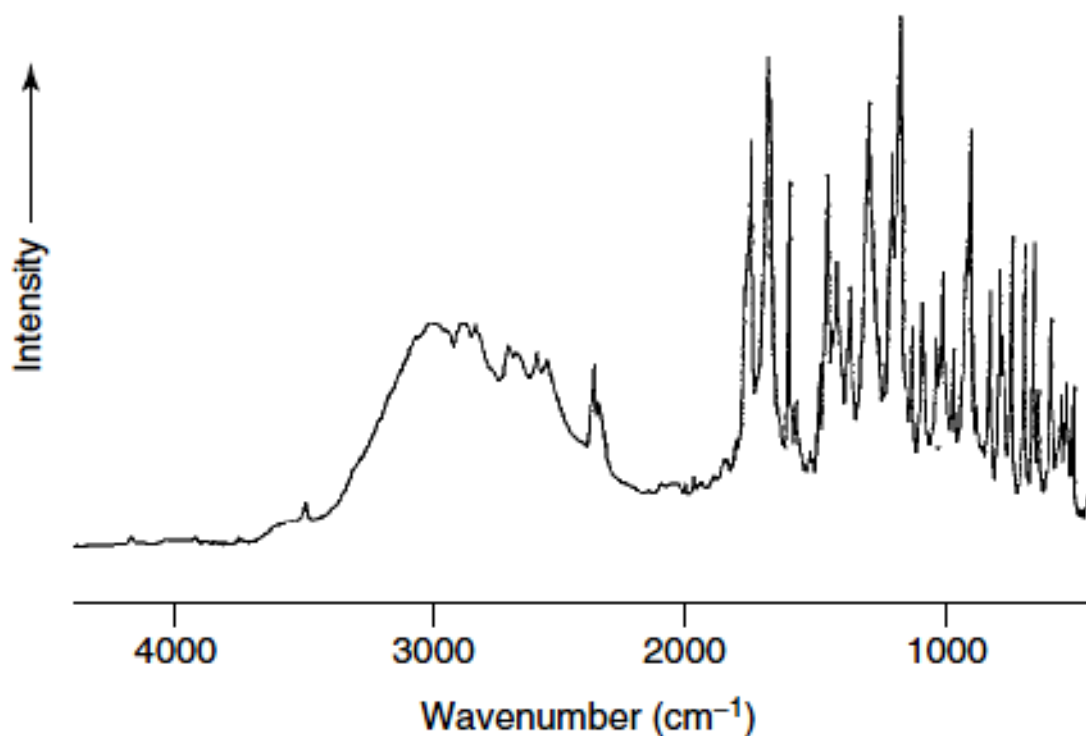

Fig. 10.8. Diffuse reflectance IR spectrum of acetylsalicylic acid

Such a spectrum may be used to identify the functional groups present in this molecule (Fig. 10.9).

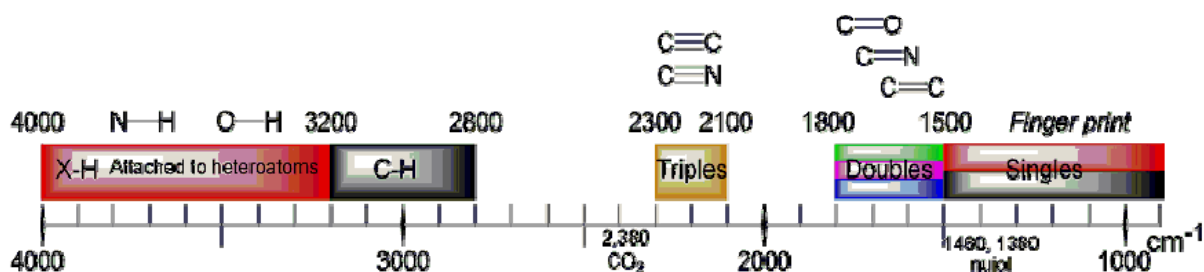

Fig. 10.9. **Characteristic IR absorption frequencies of organic functional groups**

The presence of O–H groups in acetylsalicylic acid is indicated by a broad band in the $3400\text{--}3300\text{ cm}^{-1}$ region and C–H stretching bands overlap with this band in the $3000\text{--}2800\text{ cm}^{-1}$ range. The spectrum shows two strong C = O stretching bands at $1780, 1750\text{ cm}^{-1}$, so indicating that the molecule contains carbonyl groups in different environments. The spectrum also shows strong bands at 1150 and 1100 cm^{-1} due to C–O stretching: the 1150 cm^{-1} band is due to the presence of a C–O–H group, while the 1100 cm^{-1} band is due to a C–O–C group in the structure. There is also evidence of a benzene ring, including a series of characteristic bands in the $800\text{--}500\text{ cm}^{-1}$ range due to C–H stretching in the aromatic ring. In summary, acetylsalicylic acid contains O–H, C = O, C–O–C, C–O–H and aliphatic and aromatic C–H groups.

The acetylsalicylic acid structure is illustrated in Fig. 10.10, hence confirming the presence of these functional groups.

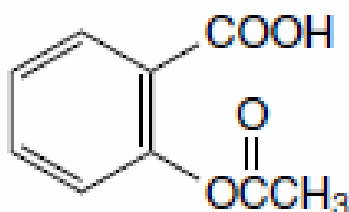

Fig. 10.10. **Structure of acetylsalicylic acid**

The notion of Near-infrared spectroscopy (NIR). The differences in the spectral properties of materials in the mid-IR and NIR are related to the fact that the absorption coefficients of the vibrational modes that are observed in the NIR are much

weaker than the absorption coefficients associated with mid-IR vibrations. This is because the NIR vibrational modes are composed of overtones of fundamental molecular vibrations. The fundamental vibrations occur in the mid-IR spectral range. The absorption bands that are present in the NIR range (13,000–4000 cm^{-1} , or 750–2500 nm) are weaker in intensity. In addition, they consist of broad, overlapping bands that arise from the combinations and overtones of the fundamental vibrations in the mid-IR (4000–400 cm^{-1} , or 2500–25,000 nm).

The Beer-Lambert law relates the absorbance of an observed band to the pathlength of the sample that the infrared energy passes through to its concentration and absorption coefficient. It can be expressed as:

$$A = \varepsilon \times C \times l,$$

where A is the absorbance and ε is the absorption coefficient;

C – the concentration;

l – the path length (or thickness of the sample).

One can look at this relationship in the following manner: as the absorption coefficient decreases, the path length of the sample must increase to measure the absorbance of a material. Conversely, if the absorption coefficient is strong, then the path length must decrease, otherwise the measured value of absorbance will saturate the detector of an infrared spectrometer.

In conclusion, NIR absorption bands are typically broad, overlapping and 10–100 times weaker than their corresponding fundamental mid-IR absorption bands. These characteristics severely restrict sensitivity in the classical spectroscopic sense and call for chemometric data processing to relate spectral information to sample properties. The low absorption coefficient, however, permits high penetration depth and, thus, an adjustment of sample thickness. This aspect is actually an analytical advantage, since it allows direct analysis of strongly absorbing and even highly scattering samples, such as turbid liquids or solids in either transmittance or reflectance mode without further pretreatment.

Near-infrared (NIR) spectroscopy and imaging are fast and nondestructive analytical techniques that provide chemical and physical information of virtually any matrix. In combination with multivariate data analysis these two methods open many interesting perspectives for both qualitative and quantitative analysis.

In recent years, NIR spectroscopy has gained wide acceptance within the pharmaceutical industry for raw material testing, product quality control and process monitoring. The growing pharmaceutical interest in NIR spectroscopy is probably a direct result of its major advantages over other analytical techniques, namely, an easy sample preparation without any pre-treatments, the possibility of separating the sample measurement position and spectrometer by use of fiber optic probes, and the prediction of chemical and physical sample parameters from one single spectrum.

Topic 11

Atomic absorption spectroscopy (AAS) for medicines quality control

Objective: to create a system of knowledge about the AAS as pharmacopoeial method of medicines quality control.

Atomic absorption spectroscopy (AAS) is a spectroanalytical procedure for the quantitative determination of chemical elements employing the absorption of optical radiation (light) by free atoms in the gaseous.

Atomic absorption spectrometry was first used as an analytical technique, and the underlying principles were established in the second half of the 19th century by R.W. Bunsen and G.R. Kirchhoff, both professors at the University of Heidelberg, Germany. The modern form of AAS method and equipment for it (Fig. 11.1) has been largely developed since the 1950s.



Fig. 11.1. Modern atomic absorption spectrometer

In analytical chemistry the technique is used for determining the concentration of a particular element (the analyte) in a sample to be analyzed. AAS can be used to determine over

70 different elements in solution or directly in solid samples employed in pharmacology, biophysics and toxicology research.

Application of AAS in pharmacy. AAS is used in *pharmaceutical analysis* for determination of metal residues in drugs remaining from the manufacturing process, for assay ions (Ca^{2+} , Mg^{2+}) in haemodialysis fluid, zinc (Zn^{2+}) in insulin, etc.

In Ph. Eur. AAS is used in a number of limit tests for metallic impurities, e.g.: magnesium and strontium in calcium acetate; palladium in carbenicillin sodium and lead in bismuth subgalate. It is also used to assay metals in a number of other preparations: zinc in zinc insulin suspension and tetracosactrin zinc injection; copper and iron in ascorbic acid; zinc in acetylcysteine; lead in bismuthsubcarbonte; silver in cisplatinum; lead in oxyprenaolol; aluminium in albumin solution and calcium, magnesium, mercury and zinc in water used for diluting haemodialysis solutions.

Principle. The technique makes use of absorption spectrometry to assess the concentration of an analyte in a sample. It requires standards with known analyte content to establish the relation between the measured absorbance and the analyte concentration and relies therefore on the Beer-Lambert Law.

In short, the electrons of the atoms in the atomizer can be promoted to higher orbitals (excited state) for a short period of time (nanoseconds) by absorbing a defined quantity of energy (radiation of a given wavelength) (Fig. 11.2).

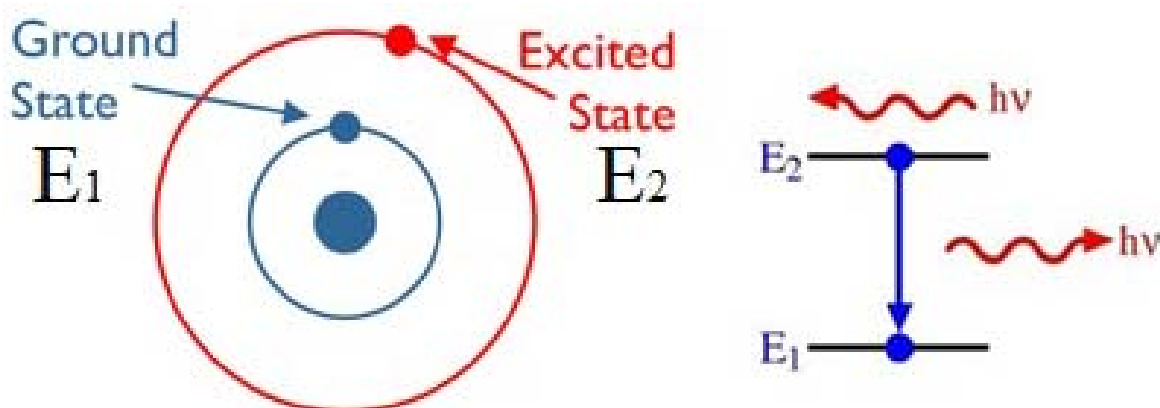

Fig. 11.2. Energetic levels of electron at ground and excited state

This amount of energy, i.e., wavelength, is specific to a particular electron transition in a particular element. In general, each wavelength corresponds to only one element, and the width of an absorption line is only of the order of a few picometers (pm), which gives the technique its elemental selectivity (Fig. 11.3).

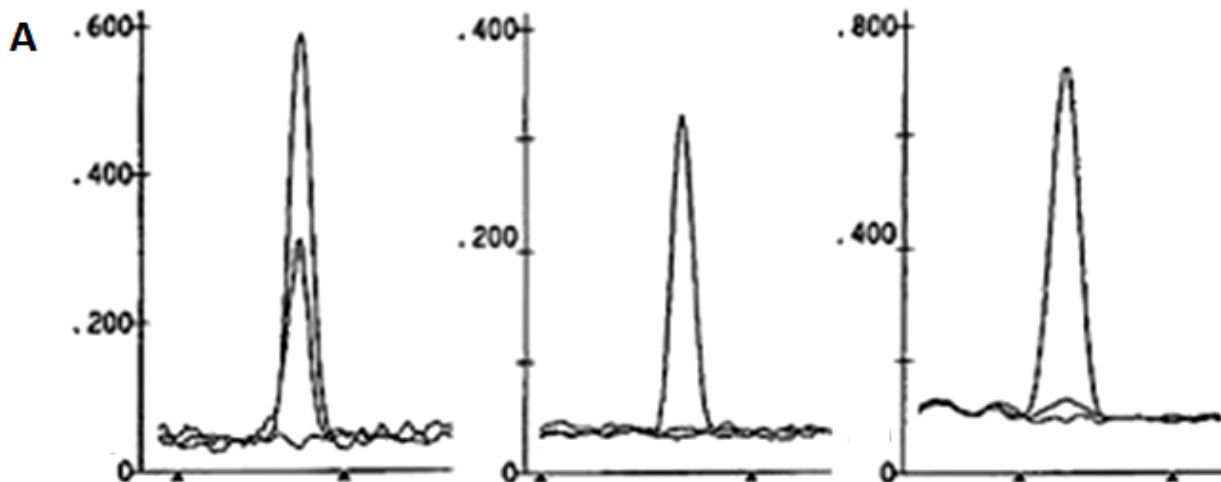

Fig. 11.3. AAS profiles of Al (167,1 nm), Cd (228,8 nm) and Cu (324,8 nm)

The radiation flux without a sample and with a sample in the atomizer is measured using a detector, and the ratio between the two values (the absorbance) is converted to analyte concentration or mass using the Beer-Lambert Law.

Instrumentation. In order to analyze a sample for its atomic constituents, it has to be atomized. Atomic absorption spectrometer block diagram includes the *flame atomizer* (Fig. 11.4). This is one of the most commonly atomizers used nowadays. Another one is an *electrothermal (graphite tube) atomizer*. Other atomizers, such as glow-discharge atomization, hydride atomization, or cold-vapor atomization might be used for special purposes.

The atoms should then be irradiated by optical radiation, and the radiation source could be an element-specific line radiation source or a continuum radiation source. The radiation then passes through a monochromator in order to separate the element-specific radiation from any other radiation emitted by the radiation source, which is finally measured by a detector.

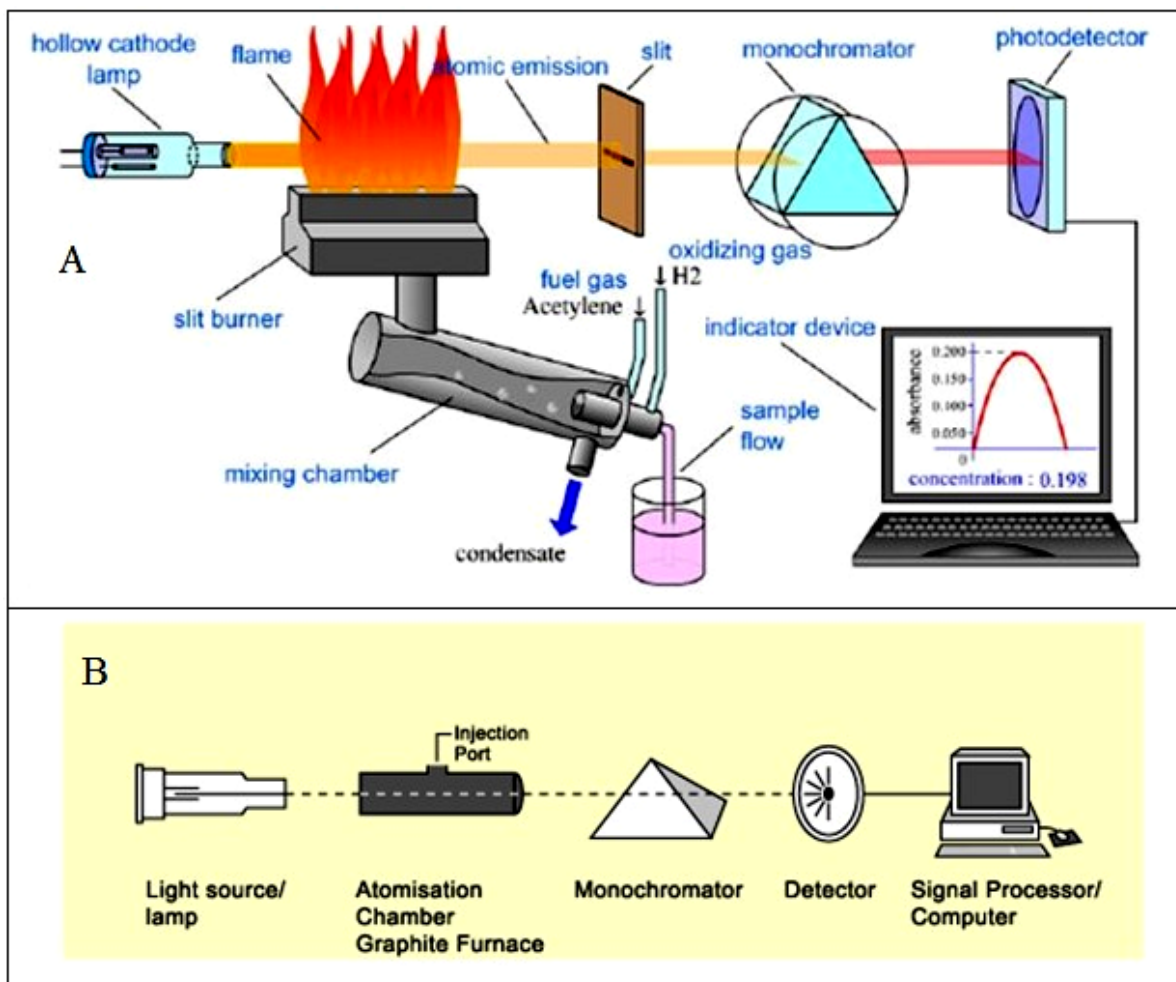

Fig. 11.4. **Atomic absorption spectrometer block diagrams:**
 A – flame atomizer, B – electrothermal (graphite tube) atomizer

The oldest and most commonly used atomizers in AAS are flames, principally the *air-acetylene flame* with a temperature of about 2300 °C and the *nitrous oxide (N₂O)-acetylene flame* with a temperature of about 2700°C (Fig. 10.4). The latter flame, in addition, offers a more reducing environment, being ideally suited for analytes with high affinity to oxygen.

Liquid or dissolved samples are typically used with flame atomizers. The sample solution is aspirated by a pneumatic analytical nebulizer, transformed into an aerosol, which is introduced into a spray chamber, where it is mixed with the flame gases and conditioned in a way that only the finest aerosol droplets (< 10 µm) enter the flame. This conditioning process is responsible that only about 5% of the aspirated sample solution reaches the flame, but it also guarantees a relatively high freedom from interference.

On top of the spray chamber is a burner head that produces a flame that is laterally long (usually 5–10 cm) and only a few mm deep. The radiation beam passes through this flame at its longest axis, and the flame gas flow-rates may be adjusted to produce the highest concentration of free atoms. The burner height may also be adjusted, so that the radiation beam passes through the zone of highest atom cloud density in the flame, resulting in the highest sensitivity.

The processes in a flame include the following stages:

- desolvation (drying) – the solvent is evaporated and the dry sample nano-particles remain;
- vaporization (transfer to the gaseous phase) – the solid particles are converted into gaseous molecules;
- atomization – the molecules are dissociated into free atoms;
- ionization – depending on the ionization potential of the analyte atoms and the energy available in a particular flame, atoms might be in part converted to gaseous ions.

Each of these stages includes the risk of interference in case the degree of phase transfer is different for the analyte in the calibration standard and in the sample. Ionization is generally undesirable, as it reduces the number of atoms that is available for measurement, i.e., the sensitivity. In flame AAS a steady-state signal is generated during the time period when the sample is aspirated. This technique is typically used for determinations in the mg L^{-1} range, and may be extended down to a few $\mu\text{g L}^{-1}$ for some elements.

Electrothermal AAS (ET AAS) using graphite tube atomizers was pioneered by B.V. L'vov at the Saint Petersburg Polytechnical Institute, Russia, since the late 1950s, and further investigated by Hans Massmann at the Institute of Spectrochemistry and Applied Spectroscopy (ISAS) in Dortmund, Germany.

The graphite furnace atomiser which is also called an electrothermal atomiser utilises an electrically heated tube made of graphite. The heated graphite furnace provides the thermal energy to break chemical bonds within the sample and produce free ground state atoms of the analyte.

Aqueous sample are acidified, usually with nitric acid, to a pH of 2,0 or less. The sample (usually $\sim 20 \mu\text{L}$ but less than

100 μL) is added to the graphite furnace either manually or automatically and evaporated at a low temperature, then ashed at a higher temperature. After ashing the current is increased causing the temperature to rise to 2000–3000 $^{\circ}\text{C}$ and the sample atomises in a few milliseconds.

The following diagram outlined the essential features of Graphite Furnace Atomic Absorption (GFAA). The sample is placed on the platform in the graphite furnace before temperature cycling through the following steps occurs:

1.	Drying Step	80–200 $^{\circ}\text{C}$	Removes solvent from sample
2.	Ashing Step	350–1600 $^{\circ}\text{C}$	Removes organic and inorganic material
3.	Atomisation Step	1800–3000 $^{\circ}\text{C}$	Generation of free analyte atoms in light path

Although a wide variety of graphite tube designs have been used over the years, the dimensions nowadays are typically 20–25 mm in length and 5–6 mm inner diameter (Fig. 11.5).

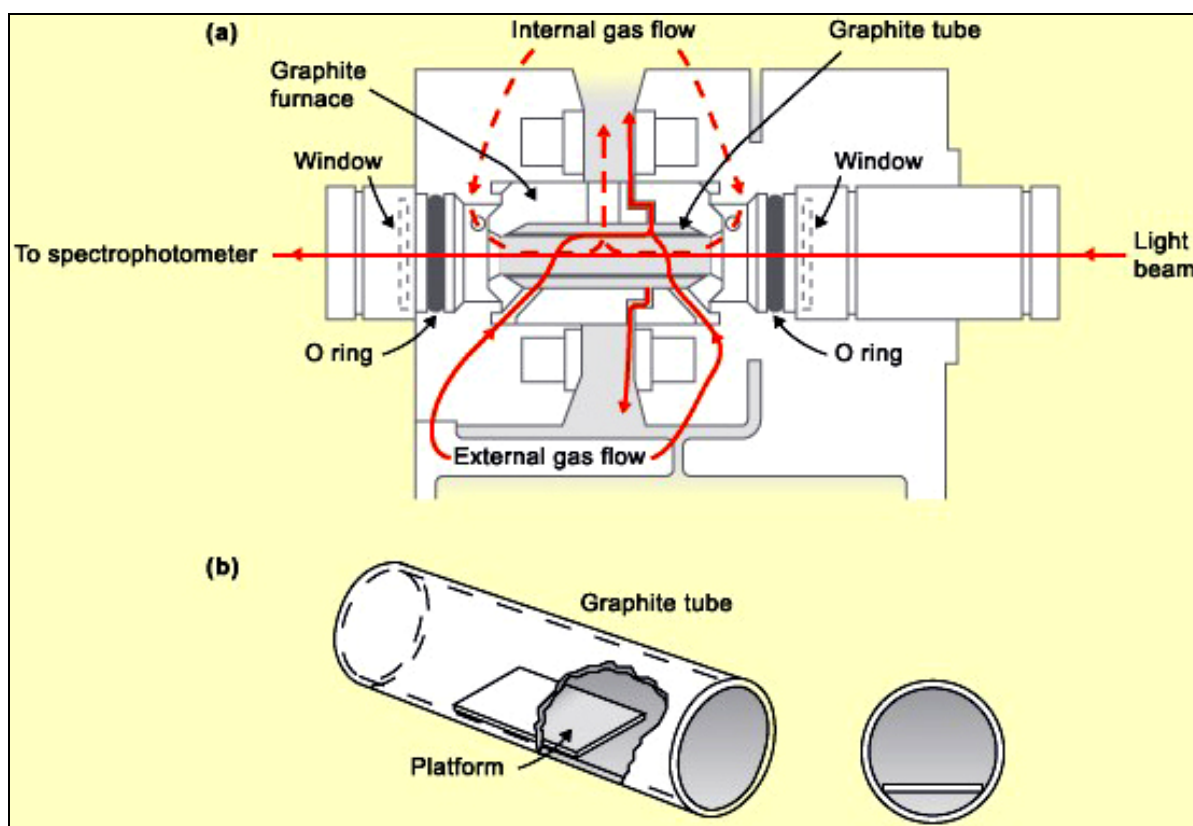

Fig 11.5. Graphite tube with graphite platform inside

With this technique liquid/dissolved, solid and gaseous samples may be analyzed directly. A measured volume (typically 10–50 μL) or a weighed mass (typically around 1 mg) of a solid sample are introduced into the graphite tube and subject to a temperature program.

The graphite tubes are heated via their osmic resistance using a low-voltage high-current power supply; the temperature in the individual stages can be controlled very closely, and temperature ramps between the individual stages facilitate separation of sample components.

Graphite furnace AAS has the following advantages and disadvantages compared to flame AAS (Table 11.1).

Table 11.1

Advantages and disadvantages two types of AAS

Graphite Furnace Advantages	Flame Advantages
Superior sensitivity – detect analytes at concentrations 10 – 100 times lower than flame	Simple
High conversion efficiency of sample into free atoms	Convenient
Low sample volumes $\sim 20 \mu\text{L}$	Excellent Results
Absorption signal is a well defined peak	Relatively short measurement time ~ 14 seconds
Peak heights and areas can be used for quantitative measurements	
Temperature is only factor involved in production of free atoms compared with flame which also must factor in the composition of the flame, gas flow and oxidant-fuel ratio	
Directs analysis of some types of liquid sample that would be inappropriate for flame AAS	
Low spectral interference due to generally higher temperatures	

Graphite Furnace Advantages	Flame Advantages
Longer measurement time than flame up to ~330 seconds depending on the temperature program used	Sensitivity Limitations Restricted Analytical Scope
Limited dynamic range	Loss of sample during process hence higher initial sample volumes required
High matrix interference	Short residence time of analyte in optical path
	Flame composition and temperature have a bearing on the results obtained

The so-called Stabilized Temperature Platform Furnace (STPF) concept, proposed by Walter Slavin, based on research of Boris L'vov, makes ET AAS essentially free from interference. The major components of this concept are:

- atomization of the sample from a graphite platform inserted into the graphite tube (L'vov platform) instead of from the tube wall in order to delay atomization until the gas phase in the atomizer has reached a stable temperature;
- use of a chemical modifier in order to stabilize the analyte to a pyrolysis temperature that is sufficient to remove the majority of the matrix components;
- integration of the absorbance over the time of the transient absorption signal instead of using peak height absorbance for quantification.

In ET AAS a transient signal is generated, the area of which is directly proportional to the mass of analyte (not its concentration) introduced into the graphite tube. This technique has the advantage that any kind of sample, solid, liquid or gaseous, can be analyzed directly. Its sensitivity is 2–3 orders of magnitude higher than that of flame AAS, so that determinations in the low $\mu\text{g L}^{-1}$ range (for a typical sample volume of 20 μL) and $\text{ng}\cdot\text{g}^{-1}$

range (for a typical sample mass of 1 mg) can be carried out. It shows a very high degree of freedom from interferences, so that ET AAS might be considered the most robust technique available nowadays for the determination of trace elements in complex matrices.

Specialized Atomization Techniques. While flame and electrothermal vaporizers are the most common atomization techniques, several other atomization methods are utilized for specialized use.

Glow-Discharge Atomization. A glow-discharge (GD) device serves as a versatile source, as it can simultaneously introduce and atomize the sample. The glow discharge occurs in a low-pressure argon gas atmosphere between 1 and 10 torr. In this atmosphere lies a pair of electrodes applying a DC voltage of 250 to 1000 V to break down the argon gas into positively charged ions and electrons. These ions, under the influence of the electric field, are accelerated into the cathode surface containing the sample, bombarding the sample and causing neutral sample atom ejection through the process known as sputtering. The atomic vapor produced by this discharge is composed of ions, ground state atoms, and fraction of excited atoms. When the excited atoms relax back into their ground state, a low-intensity glow is emitted, giving the technique its name.

The requirement for samples of glow discharge atomizers is that they are electrical conductors. Consequently, atomizers are most commonly used in the analysis of metals and other conducting samples. However, with proper modifications, it can be utilized to analyze liquid samples as well as nonconducting materials by mixing them with a conductor (e.g. graphite).

Hydride Atomization. Hydride generation techniques are specialized in solutions of specific elements. The technique provides a means of introducing samples containing arsenic, antimony, tin, selenium, bismuth, and lead into an atomizer in the gas phase. With these elements, hydride atomization enhances detection limits by a factor of 10 to 100 compared to alternative methods. Hydride generation occurs by adding an acidified aqueous solution of the sample to a 1% aqueous solution of so-

dium borohydride, all of which is contained in a glass vessel. The volatile hydride generated by the reaction that occurs is swept into the atomization chamber by an inert gas, where it undergoes decomposition. This process forms an atomized form of the analyte, which can then be measured by absorption or emission spectrometry.

Cold-Vapor Atomization. The cold-vapor technique is an atomization method limited to only the determination of mercury, due to it being the only metallic element to have a large enough vapor pressure at ambient temperature. Because of this, it has an important use in determining organic mercury compounds in samples and their distribution in the environment. The method initiates by converting mercury into Hg^{2+} by oxidation from nitric and sulfuric acids, followed by a reduction of Hg^{2+} with tin(II) chloride. The mercury is then swept into a long-pass absorption tube by bubbling a stream of inert gas through the reaction mixture. The concentration is determined by measuring the absorbance of this gas at 253,7 nm. Detection limits for this technique are in the parts-per-billion range making it an excellent mercury detection atomization method.

Radiation sources. We have to distinguish between line source AAS (LS AAS) and continuum source AAS (CS AAS). In classical LS AAS, as it has been proposed by Alan Walsh, the high spectral resolution required for AAS measurements is provided by the radiation source itself that emits the spectrum of the analyte in the form of lines that are narrower than the absorption lines. Continuum sources, such as deuterium lamps, are only used for background correction purposes. The advantage of this technique is that only a medium-resolution monochromator is necessary for measuring AAS; however, it has the disadvantage that usually a separate lamp is required for each element that has to be determined. In CS AAS, in contrast, a single lamp, emitting a continuum spectrum over the entire spectral range of interest is used for all elements. Obviously, a high-resolution monochromator is required for this technique, as will be discussed later.

Hollow cathode lamps (HCL) are the most common radiation source in LS AAS (Fig. 11.6).

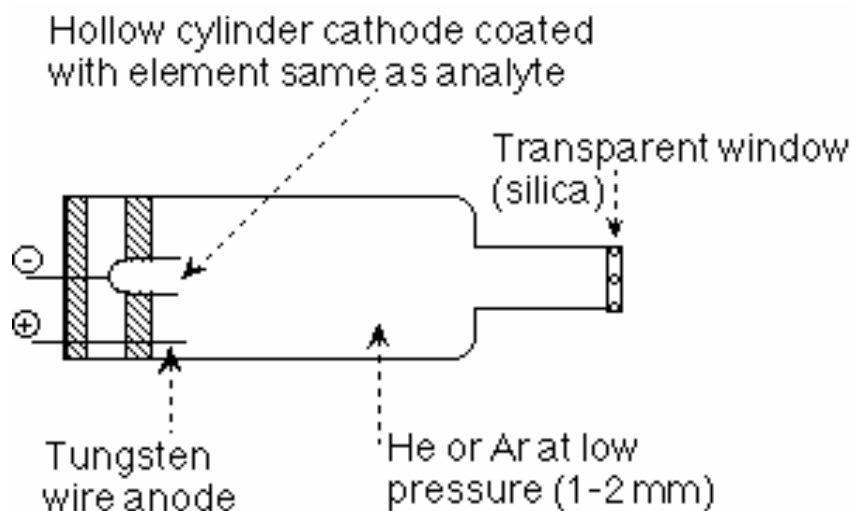

Fig. 11.6. **Hollow cathode lamp (HCL)**

Inside the sealed lamp, filled with argon or neon gas at low pressure, is a cylindrical metal cathode containing the element of interest and an anode. A high voltage is applied across the anode and cathode, resulting in an ionization of fill gas. The gas ions are accelerated towards the cathode and, upon impact on the cathode, sputter cathode material that is excited in the glow discharge to emit the radiation of the sputtered material, i.e., the element of interest. For example in the analysis of zinc, a Zn-coated cathode is used and the excitation of the Zn atoms produces a narrow band of radiation at 214 nm, which can be efficiently absorbed by the atoms in the flame. Most lamps will handle a handful of elements, i.e. 5–8. A typical machine will have two lamps, one will take care of five elements and the other will handle four elements for a total of nine elements analyzed.

Electrodeless discharge lamps (EDL) contain a small quantity of the analyte as a metal or a salt in a quartz bulb together with an inert gas, typically argon, at low pressure. The bulb is inserted into a coil that is generating an electromagnetic radio frequency field, resulting in a low-pressure inductively coupled discharge in the lamp. The emission from an EDL is higher than that from an HCL, and the line width is generally narrower, but EDLs need a separate power supply and might need a longer time to stabilize.

Deuterium HCL or even hydrogen HCL and deuterium discharge lamps are used in LS AAS for background correction purposes.

The radiation intensity emitted by these lamps is decreasing significantly with increasing wavelength, so that they can be only used in the wavelength range between 190 and about 320 nm.

When a *continuum radiation source* is used for AAS, it is necessary to use a high-resolution monochromator, as will be discussed later. In addition, it is necessary that the lamp emits radiation of intensity at least an order of magnitude above that of a typical HCL over the entire wavelength range from 190 nm to 900 nm. A special high-pressure xenon short arc lamp, operating in a hot-spot mode has been developed to fulfill these requirements.

Spectrometer. As already pointed out above, we have to distinguish between medium-resolution spectrometers that are used for LS AAS and high-resolution spectrometers that are designed for CS AAS. The spectrometer includes the spectral sorting device (monochromator) and the detector.

In *LS AAS* the high resolution that is required for the measurement of atomic absorption is provided by the narrow line emission of the radiation source, and the monochromator simply has to resolve the analytical line from other radiation emitted by the lamp. This can usually be accomplished with a band pass between 0,2 and 2 nm, i.e., a medium-resolution monochromator. Another feature to make LS AAS element-specific is modulation of the primary radiation and the use of a selective amplifier that is tuned to the same modulation frequency, as already postulated by Alan Walsh. This way any (unmodulated) radiation emitted for example by the atomizer can be excluded, which is imperative for LS AAS. Photomultiplier tubes are the most frequently used detectors in LS AAS, although solid state detectors might be preferred because of their better signal-to-noise ratio.

Spectrometers for CS AAS. When a continuum radiation source is used for AAS measurement it is indispensable to work with a high-resolution monochromator. The resolution has to be

equal to or better than the half width of an atomic absorption line (about 2 pm) in order to avoid losses of sensitivity and linearity of the calibration graph. The research with high-resolution (HR) CS AAS was pioneered by the groups of O'Haver and Harnly in the USA, who also developed the (up until now) only simultaneous multi-element spectrometer for this technique. The break-through, however, came when the group of Becker-Ross in Berlin, Germany, built a spectrometer entirely designed for HR-CS AAS. The first commercial equipment for HR-CS AAS was introduced by Analytik Jena (Jena, Germany) at the beginning of the 21st century, based on the design proposed by Becker-Ross and Florek. These spectrometers use a compact double monochromator with a prism pre-monochromator and an echelle grating monochromator for high resolution. A linear charge coupled device (CCD) array with 200 pixels is used as the detector. The second monochromator does not have an exit slit; hence the spectral environment at both sides of the analytical line becomes visible at high resolution. As typically only 3–5 pixels are used to measure the atomic absorption, the other pixels are available for correction purposes. One of these corrections is that for lamp flicker noise, which is independent of wavelength, resulting in measurements with very low noise level; other corrections are those for background absorption, as will be discussed later.

Background absorption and background correction.

The relatively small number of atomic absorption lines (compared to atomic emission lines) and their narrow width (a few pm) make spectral overlap rare; there are only very few examples known that an absorption line from one element will overlap with another. Molecular absorption, in contrast, is much broader, so that it is more likely that some molecular absorption band will overlap with an atomic line. This kind of absorption might be caused by un-dissociated molecules of concomitant elements of the sample or by flame gases. We have to distinguish between the spectra of di-atomic molecules, which exhibit a pronounced fine structure, and those of larger (usually tri-atomic) molecules that don't show such fine structure. Another source of background absorption, particularly in ET AAS, is

scattering of the primary radiation at particles that are generated in the atomization stage, when the matrix could not be removed sufficiently in the pyrolysis stage.

All these phenomena, molecular absorption and radiation scattering, can result in artificially high absorption and an improperly high (erroneous) calculation for the concentration or mass of the analyte in the sample. There are several techniques available to correct for background absorption.

Background correction techniques in LS AAS. In LS AAS background absorption can only be corrected using instrumental techniques, and all of them are based on two sequential measurements, firstly, total absorption (atomic plus background), secondly, background absorption only, and the difference of the two measurements gives the net atomic absorption. Because of this, and because of the use of additional devices in the spectrometer, the signal-to-noise ratio of background-corrected signals is always significantly inferior compared to uncorrected signals. It should also be pointed out that in LS AAS there is no way to correct for (the rare case of) a direct overlap of two atomic lines. In essence there are some techniques used for background correction in LS AAS.

Deuterium background correction. This is the oldest and still most commonly used technique, particularly for flame AAS. In this case, a separate source (a deuterium lamp) with broad emission is used to measure the background absorption over the entire width of the exit slit of the spectrometer. The use of a separate lamp makes this technique the least accurate one, as it cannot correct for any structured background. It also cannot be used at wavelengths above about 320 nm, as the emission intensity of the deuterium lamp becomes very weak. The use of deuterium HCL is preferable compared to an arc lamp due to the better fit of the image of the former lamp with that of the analyte HCL.

Zeeman-effect background correction. An alternating magnetic field is applied at the atomizer (graphite furnace) to split the absorption line into three components, the π component, which remains at the same position as the original absorption

line, and two σ components, which are moved to higher and lower wavelengths, respectively (see Zeeman Effect). Total absorption is measured without magnetic field and background absorption with the magnetic field on. The π component has to be removed in this case, e.g. using a polarizer, and the σ components do not overlap with the emission profile of the lamp, so that only the background absorption is measured.

PART II. Laboratory Practice

Laboratory Practice Session 1

**COMMON APPROACHES
FOR QUALITY CONTROL OF DRUGS.
HARMONIZATION OF PHARMACOPOEIAS**

I. Questions and tasks for discussion:

1. Explain the differences between the terms – «drug», «medicine», «pharmaceutical substance», «dosage form».

2. What are the regulations of medicines quality and at what stages of drug preparation it is necessary to use them?

3. What is Pharmacopeia, State Pharmacopeia?

4. Explain differences between the two types of regulations – «individual monographs» and «general monographs.

5. What do you know about the world's leading pharmacopoeias (Ph. Eur., USP and JP)?

6. List the features of the International Pharmacopoeia.

7. List the main features of the British Pharmacopoeia.

8. What is the harmonization of the pharmacopoeias?

9. Clarify the abbreviations: ICH, EDQM, PDG, PMDA, USP? What are the main purposes of these organizations?

II. Examine and compare general articles of leading world pharmacopoeias.

Examine the proposed articles (appendix 1) from different pharmacopoeias: European, Japanese and U.S. Pharmacopoeia. Pay attention to the article title and to the pharmacopoeial section, which includes this article. Find similarities and differences in the methods of analysis. Fill the table according to the plan:

1. Identify the purpose of the test – which drug qualities does it determine?
2. Depict the general scheme of the test, write (where possible) chemical reaction equation.
3. Indicate test conditions: reagent concentration, temperature, time, etc.
4. Make a conclusion about the harmonization degree of these pharmacopoeial articles.

№	Ph. Eur. (7th ed.)	JP (16th ed.)	USP (31th ed.)
1	2. Methods of analysis 2.4. Limit tests	1. Chemical Methods	Chemical tests and assays, Limit tests
	2.4.13. Sulfates	1.14. Sulfate limit test	221. Chloride and Sulfate

№	Ph. Eur. (7 th ed.)	JP (16 th ed.)	USP (31 th ed.)
2	—	1. Chemical Methods <i>1.15 Readily carbonizable substances test</i>	Chemical tests and assays, Limit tests <i>271. Readily carbonizable substances test</i>
3	2. Methods of analysis 2.4. Limit tests <i>2.4.14. Sulfated ash</i>	2. Physical Methods <i>2.44. Residue on Ignition test</i>	Chemical tests and assays, Limit tests <i>281. Residue on Ignition test</i>

№	Ph. Eur. (7 th ed.)	JP (16 th ed.)	USP (31 th ed.)
4	2. Methods of analysis, 2.2. Physical and physicochemical methods 2.2.32. Loss on drying	2. Physical Methods 2.41. Loss on drying test	Physical tests and determinations 731. Loss on drying
5	Loss on ignition – test is included in monographs	2. Physical Methods 2.43. Loss on ignition test	Loss on ignition – test is included in monographs

III. Study the table below. Find and represent in writing form similarities and differences in Pharmacopoeias

<p align="center">European Pharmacopoeia (<i>Ph. Eur.</i>) <i>Inter-governmental</i></p>	<p align="center">United States Pharmacopoeia <i>Independent of government</i></p>	<p align="center">Japanese Pharmacopoeia <i>Governmental</i></p>
<p>The European Pharmacopoeia of the Council of Europe is a pharmacopoeia, listing a wide range of active substances and excipients used to prepare pharmaceutical products in Europe. It includes more than 2000 specific and general monographs, including various chemical substances, antibiotics, biological substances; Vaccines for human or veterinary use; Immunosera; Radiopharmaceutical preparations; Herbal drugs; Homoeopathic preparations and homoeopathic stocks. It also contains Dosage forms, General monographs, Materials and Containers, Sutures; 268 General methods with figures or chromatograms and 2210 reagents</p>	<p>It is the official pharmacopoeia of the United States, published dually with the National Formulary as the USP-NF. The United States Pharmacopoeial Convention (usually also called the USP) is the nonprofit organization that owns the trademark and copyright to the USP-NF and publishes it every year. Prescription and over-the-counter medicines and other health care products sold in the United States are required to follow the standards in the USP-NF. USP also sets standards for food ingredients and dietary supplements. The United States Pharmacopoeia and The National Formulary (USP–NF) is a book of public</p>	<p>Japanese Pharmacopoeia (JP) is a book of official pharmaceutical standards in Japan, prepared by the JP secretariat in PMDA and established by the MHLW. It is evaluated and reviewed in expert committees periodically held by the JP secretariat. Pharmaceuticals and Medical Devices Agency (PMDA) is an incorporated administrative agency, established under the Act on PMDA in 2004. It conducts scientific and technical evaluations and reviews on pharmaceuticals and medical devices under the entrustment and medical devices, under the entrustment from the Ministry of Health, Labor and Welfare (MHLW).</p> <p align="right">17th edition</p>

European Pharmacopoeia (<i>Ph. Eur.</i>) <i>Inter-governmental</i>	United States Pharmacopoeia <i>Independent of government</i>	Japanese Pharmacopoeia <i>Governmental</i>
<p>are described. The monographs give quality standards for all the main medicines used in Europe. All medicines sold in the 36 Member States of the European Pharmacopoeia must comply with these quality standards so that consumers have a guarantee for products obtained from pharmacies and other legal suppliers. The European Pharmacopoeia is developed by the European Directorate for the Quality of Medicines (<i>EDQM</i>) and is a part of the Council of Europe, Strasbourg, France. It has been created by the <i>Convention on the elaboration of a European Pharmacopoeia</i> from 1964. Currently there are 37 members of the European Pharma-</p>	<p>pharmacopoeial standards. It contains standards for (chemical and biological drug substances, dosage forms, and compounded preparations), excipients, medical devices, and dietary supplements. USP–NF is a combination of two compendia, the United States Pharmacopoeia (USP) and the National Formulary (NF). Monographs for drug substances, dosage forms, and compounded preparations are featured in the USP. Monographs for dietary supplements and ingredients appear in a separate section of the USP. Excipient monographs are in the NF. A monograph includes the name of the ingredient or preparation; the definition; packaging,</p>	

European Pharmacopoeia (<i>Ph. Eur.</i>) <i>Inter-governmental</i>	United States Pharmacopoeia <i>Independent of government</i>	Japanese Pharmacopoeia <i>Governmental</i>
<p>copoeia Commission: Austria, Belgium, Bosnia and Herzegovina, Bulgaria, Croatia, Cyprus, Czech Republic, Denmark, Estonia, Finland, France, Germany, Greece, Hungary, Iceland, Ireland, Italy, Latvia, Lithuania, Luxembourg, Malta, Montenegro, Netherlands, Norway, Poland, Portugal, Romania, Serbia, Slovak Republic, Slovenia, Spain, Sweden, Switzerland, Republic of Macedonia, Turkey, United Kingdom, and the European Union. In these countries and the European Union the Ph. Eur. is the official pharmacopoeia. Additional local pharmacopoeias may exist (e. g. in United Kingdom and Germany). Not all of</p>	<p>storage, and labeling requirements; and the specification. The specification consists of a series of tests, procedures for the tests, and acceptance criteria. These tests and procedures require the use of official USP Reference Standards. Medicinal ingredients and products will have the stipulated strength, quality, and purity if they conform to the requirements of the monograph and relevant general chapters. Tests and procedures referred to in multiple monographs are described in detail in the USP–NF general chapters. The General Notices provide definitions for terms used in the monographs, as well as information that is necessary to inter-</p>	

European Pharmacopoeia (<i>Ph. Eur.</i>) <i>Inter-governmental</i>	United States Pharmacopoeia <i>Independent of government</i>	Japanese Pharmacopoeia <i>Governmental</i>
<p>these countries are member states of the European Union.</p> <p>Observers from 20 member and non-member states of the Council of Europe and international organizations take part on sessions of the European Pharmacopoeial Commission: Albania, Algeria, Australia, Belarus, Brazil, Canada, China, Georgia, Israel, Madagascar, Malaysia, Morocco, Kazakhstan, Russian Federation, Senegal, Syria, Tunisia, Ukraine, United States of America, and the WHO.</p> <p>7th edition</p>	<p>pret the monograph requirements. USP is proposing to revise the General Notices for the USP and NF. The U.S. Federal Food, Drug, and Cosmetics Act designates the USP–NF as official compendia for drugs marketed in the United States. A drug product in the U.S. market must conform to the standards in USP–NF to avoid possible charges of adulteration and misbranding.</p> <p>31th edition</p>	

IV. Read the sentences. Say, if it is true (T) or false (F)?

1. <i>Readily Carbonizable Substances Test</i> is a method to examine the minute impurities contained in drugs, which are readily colored by addition of concentrated acetic acid.	
2. <i>Loss on ignition test</i> is carried out for drugs of organic nature, which lose a part of the components or impurities during ignition.	
3. <i>Loss on Ignition Test</i> is a method to measure the loss in mass when the sample is ignited under the conditions specified in monograph.	
4. To conduct <i>Loss on drying test</i> you can dry the substance in exsiccator at 101,3 kPa or under vacuum (different pressure, sometimes with heating) and in the oven at temperature, specified in monograph.	
5. In <i>Sulfate limit test</i> the solution of BaCl_2 is used as a reagent, and the standard solution of H_2SO_4 is used as a control solution.	
6. <i>Residue on ignition test (Sulfated ash)</i> is necessary stage of heavy metals limit test. <i>Residue on ignition test</i> is carried out at $T > 400^\circ\text{C}$ in the presence of H_2SO_4	

V. Look at the scheme. Cross out the direction where sulfuric acid is not required during the test:

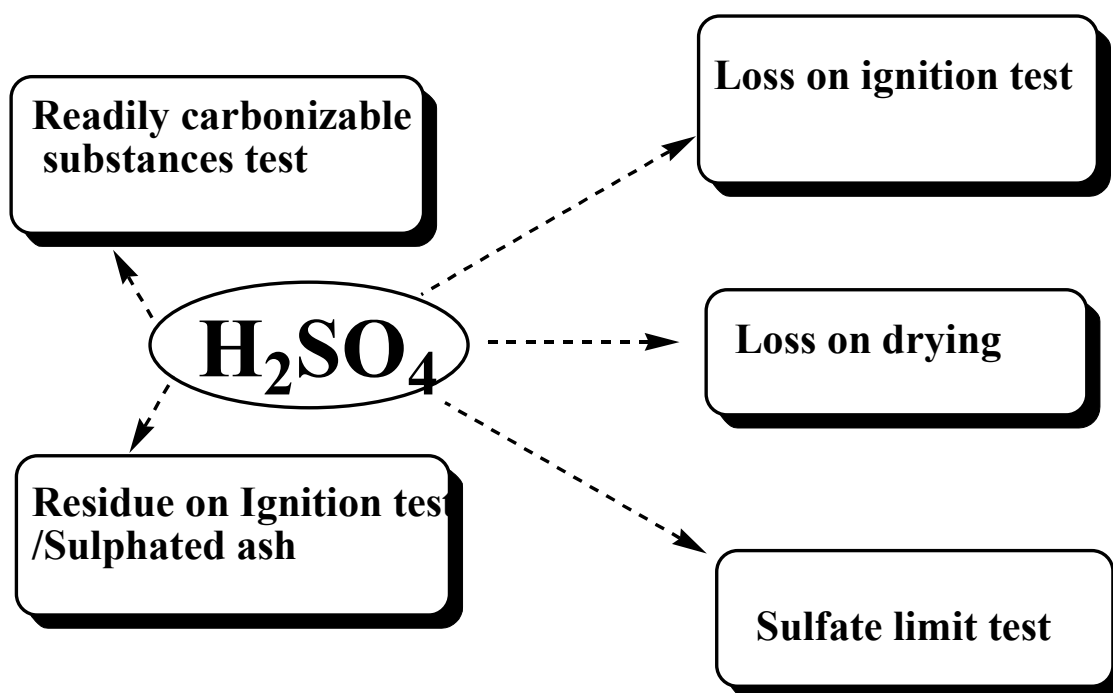

VI. Self-test:

1. What is pharmacopoeias harmonization (negotiation)?

- a) The development and implementation of standards of medicines as the basis of their safety and effectiveness.
- b) The free movement of medicines in Europe.
- c) Quality assurance of drug substances and excipients when importing or exporting from Europe.
- d) Coordinated control of production and quality of medical products in connection with the free movement of medicines.

2. Pharmacopoeia harmonization – is harmonization of requirements for quality of medicines between:

- a) European countries.
- b) Europe and Russia.
- c) Britain, France and the USA.
- d) European Pharmacopoeia, the U.S., Japan and other countries pharmacopoeias.

3. According Ph.Eur. in the test «loss on drying» the substance is dried under conditions:

- a) In an exsiccator over a reagent to absorb water.
- b) In vacuum.
- c) In vacuum at a given temperature.
- d) In an oven at a certain temperature.

Laboratory practice session 2

**PHARMACEUTICAL ANALYSIS DATA TREATMENT.
VALIDATION OF ANALYTICAL PROCEDURES**

I. Questions and tasks for discussion:

1. The terms «error in analysis» and «uncertainty of measurement». Classification and control of errors.

2 Statistical treatment and reporting of results. Confidence interval.

3. What are the two main validation parameters? What types of errors do they characterize?

4. How many measurements must be performed to obtain statistically reliable data during the validation process?

5. What are the main ways for achieving the accuracy?

6. Give your definition of «repeatability» and «reproducibility».

II. Project «Validation of Analytical Procedure».

Description

Pharmaceutical company is planning to sell generic. To confirm that the manufactured product meets quality requirements, the company orders a testing laboratory to develop an analytical procedure of quantitative determination of acetaminophen (assay).

For the research laboratory the possibility to get this order depends on the reliability and on validity of its analytical procedures.

So, if the first task for you is to select and evaluate regulation validation parameters in terms of ICH, the second task will be to assess the ability of testing laboratory to provide competent performance validation.

When the Lab receives from the Customer a list with approved ICH validation parameters required for the HPLC determination of acetaminophen, Lab should make sequence (order) of their evaluation. Along the way, set the appropriate limits for specification parameters (Table 2.1).

Table 2.1

Necessary validation parameters & specifications

Validation parameter	Acceptance criteria (norms)
Specificity	Homogeneity of the peaks, resolution coefficient (R_s) > 1,5%
Linearity	Correlation coefficient (r) > 0,998
Range	Homogeneity of dispersion confirmed by Fischer method
Accuracy	Recovery is 98–102% (spiked placebo, standard addition of analyte to placebo)
Repeatability	RSD < 1,5%

Assessment of relevant validation parameters is performed according to the scheme shown in Fig. 2.1. Selected validation parameters will be determined after the necessary research is conducted.

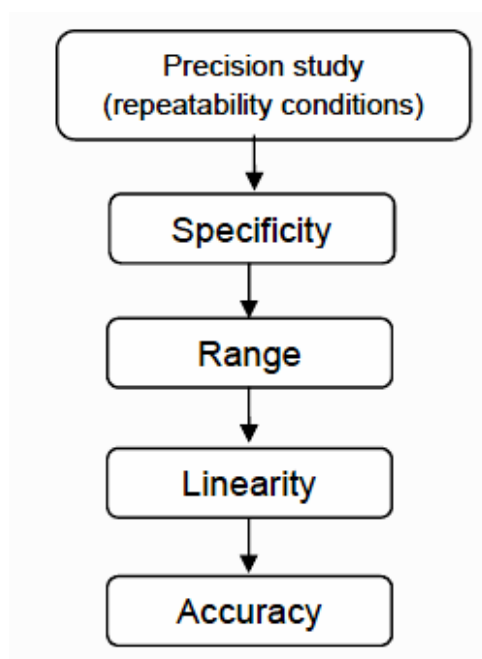

Fig. 2.1. Sequence of validation parameters determination

1. Precision study (repeatability conditions).

HPLC separation and determination of acetaminophen in testing solutions was performed six times in repeatability conditions. The mass concentration of acetaminophen in testing solutions equals 30 mg/l. Peak areas are shown in the table 2.2.

Table 2.2

HPLS assay results: chromatographic peak areas

Run	Peak area, u
1	63 120
2	62 601
3	63 887
4	62714
5	62 986
6	63 407

Task

Using relevant software or calculator estimate the Standard Deviation and RSD, % (coefficient of variation).

2. Specificity Study.

The expected value of mass concentration of acetaminophen in the sample was 30 mg/l. The Fig. 2.2 shows the HPLC chromatogram obtained with the assay of sample. It can be seen that except the main peak of acetaminophen, there is a peak of relative component. Homogeneity of the peaks was performed by the means of chromatography-mass spectrometry to assess the specificity. The results showed that the peaks belong to pure

substances, the homogeneity of the peaks in this case was confirmed.

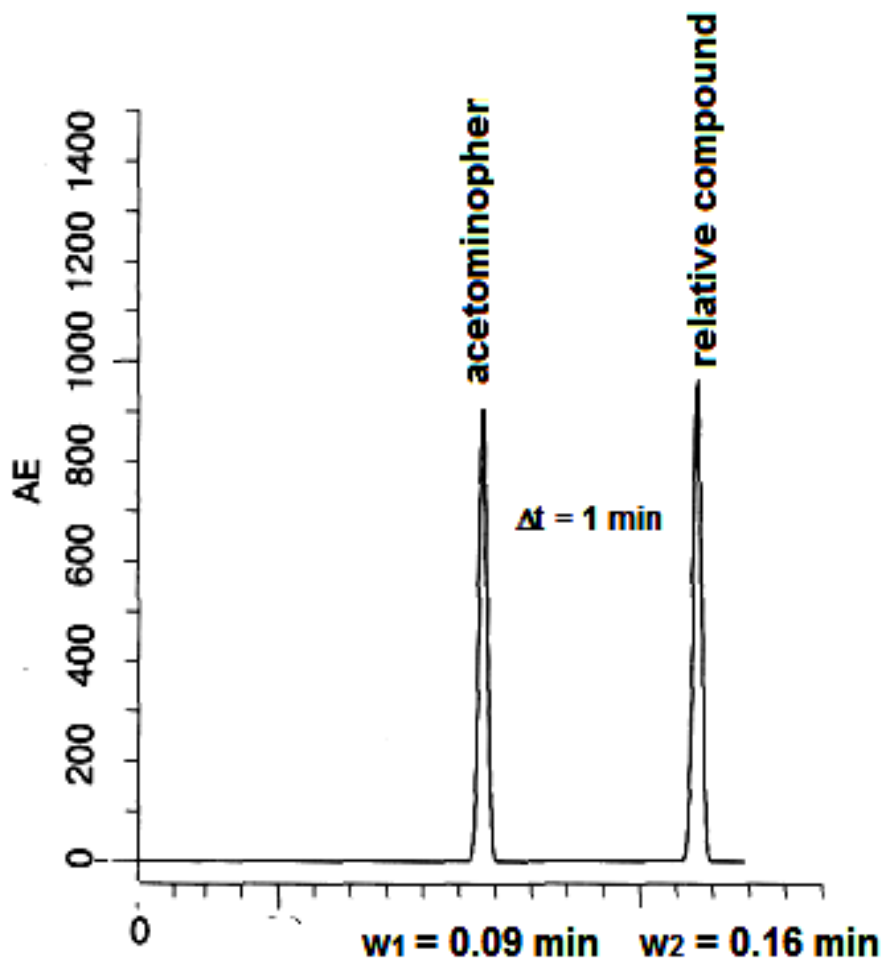

Fig. 2.2. Chromatogram of standard sample with known acetaminophen concentration

Task

Calculate resolution (R_s), which defines the degree of separation. Use chromatographic parameters (Fig. 2.8) and equation:

$$R_s = \frac{2\Delta t}{w_1 + w_2},$$

where Δt – distance between the peaks;
 w – width of each peak at the base as shown in Fig. 2.8.

3.  Range Study.

Six calibration solutions with acetaminophen concentration from 20 to 45 mg/l were prepared to test the range for homogeneity dispersion. The measured peak areas are shown in Table 2.3.

Table 2.3

HPLS results for calibration solutions

Peak area, u ($c_{\text{acetaminophen}} = 20 \text{ mg/l}$)	Peak area, u ($c_{\text{acetaminophen}} = 45 \text{ mg/l}$)
45 530	99 472
45 209	98 912
44 889	99 130
45 022	99 899
45 410	99 451
44 706	98 971

Homogeneity of dispersion at the end of the calibration curve was performed by Fisher method.

Task

Calculate Fisher statistics (ζ) using equation:

$$\zeta = \frac{S_1^2}{S_2^2},$$

where S_1, S_2 – dispersions of the two series of chromatographic data, $S_1^2 > S_2^2$.

If the confidence level $P=95\%$ and the number of degrees

$$f_1 = n_1 - 1 = 5 \text{ and } f_2 = n_2 - 1 = 5,$$

critical value equals 5,05. Make a conclusion about the homogeneity of dispersions of the two series of chromatographic data.

4. **Linearity Study.**

To estimate the concentration (mass) of acetaminophen in the test solution calibration solutions were prepared and the area of the peaks was measured using relevant software. The HPLS results are presented in Table 2.4.

Table 2.4

HPLC analysis of the calibration solutions of acetaminophen

$C_{\text{acetaminophen}}$, mg/l	Peak area, u
20	45 450
25	55 290
30	65 165
35	76 254
40	88 019
45	99 309

Task

Using data shown in Table 2.4 and Microsoft Excel construct a calibration linear curve « $C_{\text{acetaminophen}} - \text{peak area}$ » and

obtain linear regression equation. Calculate correlation coefficient (r).

5. Accuracy Study.

To determine the recovery, % three placebo samples were spiked by 24, 30 and 36 mg of paracetamol respectively («3 × 3 method»). Concentrations of paracetamol obtained by HPLC analysis are shown in the Table 2.5.

Table 2.5

HPLC analysis of the calibration solutions of acetaminophen

Run	Added amount of acetaminophen, mg	Obtained amount of acetaminophen, mg			Mean, mg
1	24	20,2	21,6	21,5	21,1
2	30	26,8	27,5	26,6	27,0
3	36	32,5	32,6	31,6	32,2

Task

Using data shown in Table 2.6 calculate recovery, % by the equation:

$$\text{recovery, \%} = \frac{X_{\text{measured}}}{X_{\text{true}}} \times 100.$$

6. Results and reporting.

Summarize the results of validation studies in the table 2.6
Check the acceptance criteria: are the established norms fulfilled? Fill in the last column of the table (Yes/No).

Answer the question: Would you trust this laboratory to perform an assay?

Table 2.6

Validation results

Validation parameter	Acceptance criteria	Result	Acceptance criteria met (Yes/No)
Specificity	homogeneity of the peaks is observed when resolution $R_s > 1,5\%$	homogeneity of the peaks is observed when $R_s =$	
Linearity	correlation coefficient $r > 0,998$	correlation coefficient $r =$	
Range	Fischer method (P=95%, n=6) statistics over the table value	Statistics value = Critical value =	
Accuracy	Recovery = 98–102% (spiked placebo method, standard addition of analyte to placebo)	Recovery =	
Repeatability	RSD < 1,5%	RSD =	

III. Self-test:

1. Metrological certification of analytical procedure is – ...

- a) its qualification.
- b) its validation.
- c) laboratory verification of the its suitability.
- d) within-laboratory quality control.

2. Ways to identify and eliminate systematic errors in analysis ...

- a) varying the sample size.
- b) use standard additions of analytes.
- c) use of reference materials.
- d) application of all mentioned ways.

3. Validation of analytical procedure is performed by evaluation the following characteristics (parameters):

- a) trueness
- b) repeatability
- c) robustness
- d) selectivity (specificity)
- e) Linearity
- f) detection limit
- g) quantitation limit

4. Random errors ...

- a) characterize the precision of analysis.
- b) can be estimated by statistical treatment methods.
- c) can not be estimated by statistical treatment methods.
- d) have causes that can not be established definitely.

5. Systematic errors ...

- a) characterize the accuracy of analysis.
- b) characterize statistically significant difference between the average and the true value.
- c) can be identified using reference standards, certified metrological procedures or by standard additions method.

6. Precision evaluation includes assessing:

- a) trueness
- b) repeatability
- c) accuracy
- d) limit of detection
- e) reproducibility

Laboratory practice session 3

**THERMAL ANALYSIS
IN LEADING PHARMACOPOEIAS.
MELTING POINT DETERMINATION OF API**

I. Questions and tasks for discussion:

1. What is Thermal Analysis? What types of thermal analysis are described in the pharmacopoeias: Ph. Eur., JP, USP?

2. What quality levels of drug products can be examined by means of these methods?

3. What is the difference between the common and differential type of thermal analysis? Describe the main advantages and disadvantages.

4. Figure the general view of the thermoanalytical curve.

5. Characterize DSC method. How does DSC differ from the DTA?

6. Comment the use of TGA for determination «loss on drying», «loss on ignition», «water content», «residue on ignition». Figure thermoanalytical curves corresponding to each of them.

II. Analytical work with pharmacopoeial general chapters «Melting point» (as an indicator of the quality of API).

Examine the proposed Eur. Ph., JP, Int. Pharmacopoeial general chapters – «Melting point determination». Complete the table.

JP	Ph. Eur.	Int. Ph.
1. Capillary method is applied for easily dispersible crystalline substances...	1. Capillary method	1. Capillary method
2. Open capillary method (both ends of the capillary are open) is applied to substances such as fats, fatty acids...	2. Open capillary method	2. Open capillary method
3. Drop point	3. Instantaneous method	—
—	4. Drop point	—

III. Lab practice: Determine the melting point of one of the proposed APIs. According to the results of the test fill in the form:

<p>Melting point determination of API by capillary method: Normative document (ND) 2.2.14. MELTING POINT – CAPILLARY METHOD _____ Testing sample _____ Batch/Lot _____</p>
<p>Manufacturer _____ Limits _____</p>
<p>Apparatus and materials: 1. Instrument _____ 2. Capillaries _____ 3. Sample bottle _____ 3. Desiccator with desiccant _____ 4. Glass tubes _____ 5. Mortar and pestle _____</p>
<p>Procedure description: Find in Eur. Ph. 2.2.14. MELTING POINT – CAPILLARY METHOD</p>

Test results

№ capillary with sample	$T_{\text{meas.}}, \text{ }^{\circ}\text{C}$	$\bar{T}, \text{ }^{\circ}\text{C}$	$\Delta = T_{\text{meas.}} - T_{\text{cert.}}, \text{ }^{\circ}\text{C}$
1			
2			
3			

Δ – temperature measurement error in the heater unit, $^{\circ}\text{C}$;
 $T_{\text{cert.}}$ – certified reference standard melting point specified in the enclosed certificate, $^{\circ}\text{C}$.

Conclusion: _____

IV. Self-test:

1. In accordance with JP melting point is the temperature at which ...

- a) liquid and solid phase of a substance are in an equilibrium.
- b) a solid sample is completely melted, ie transferred to the liquid phase.
- c) there is a sharp jump in enthalpy ΔH in $\Delta H - T$ curve.

2. The melting point determination is used in drugs quality control for ...

- a) API identification tests.
- b) evaluation of purity of API (impurities limit tests).
- c) evidence of chiral purity of drug substance.

3. In accordance with JP there are methods to determine the melting point for ...

- a) substances whose purity is comparably high, which can be pulverized and soluble in water.
- b) substances are insoluble in water and hardly dispersible – fats, fatty acids, waxes, waxes.
- c) paraffin and petroleum.
- d) the nature of the substance does not matter.

4. JP Method 1 for melting point determination ...

- a) is applied for those substances of which the purity is comparably high and which can be pulverized, soluble in water.
- b) involves the use of thermometer with an immersion line.
- c) involves the use of calibration high-purity substances: acetanilide, acetofenitidine, caffeine, sulfanilamide, sulfapyridine, vaniline.
- d) involves the use of thermometers with different temperature ranges: 40–100, 90–150, 140–200, 190–250, 240–320 °C.
- e) involves different accuracy in different temperature ranges – from up to $\pm 0,5 \pm 1,0$ °C.

5. JP Method 2 for melting point determination ...

a) is applied to substances, that are insoluble in water which can not be pulverized such as fats, fatty acids, paraffin or waxes.

b) involves the use of open capillary.

c) pre-melting the substance at the lowest possible temperature, substance should be placed in ice for 1 hour or stored at temperatures below 10 °C during the day.

d) pre-heating the substance to a temperature of about 5 °C below the expected melting temperature, followed by heating at a rate of not more than 1 °C/min.

6. JP Method 3 for melting point determination ...

a) is applied to substances such paraffins or waxes.

b) use of vessel with liquid, in which sample with a thermometer are placed, and a heating vessel.

c) pre-heating to 30 °C at a rate of 2 °C per minute, and further heating at a rate of not more than 1 °C per minute.

d) implies melting point is temperature at which the first drop of the sample leaves the thermometer.

Laboratory practice session 4

**OPTICAL METHODS
FOR MEDICINES QUALITY CONTROL.
POLARIMETRY**

I. Questions and tasks for discussion:

1. Why doesn't a racemic mixture show optical activity?

2. Does the following image show optically active molecules? Why?

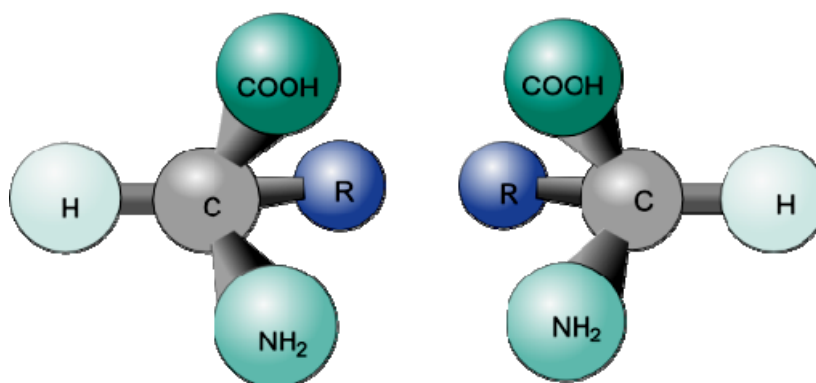

3. What would happen if your feet were not optical isomers of each other?

4. Your friend has tuberculosis. Assuming you like your friend and you want him to live, which isomer of ethambutol do you give him and why?

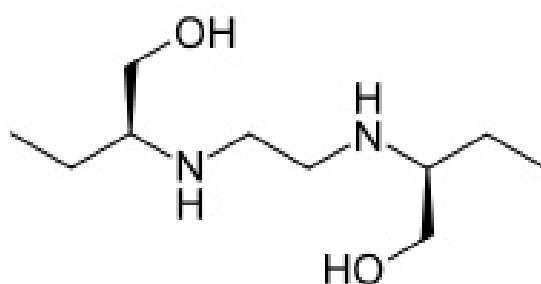

5. Draw each compound's enantiomer:

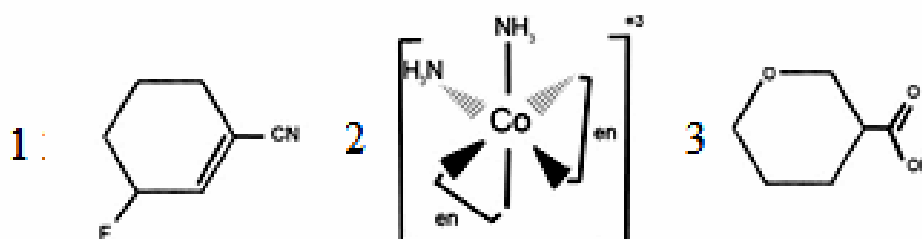

II. Do the tasks:

1. Determine the optical purity of a racemic mixture:

$$[\alpha]_{\text{pure samples}} = \pm 23,1^\circ.$$

Answer. The specific rotation, $[\alpha]$, of the racemate is expected to be 0, since the effect of one enantiomer cancels the other out, molecule for molecule.

$$\text{Optical purity, } \omega\% = 100\% [\alpha]_{\text{mixture}} / [\alpha]_{\text{pure sample}} = \\ = 100\% (0) / +23,1^\circ = 0\%.$$

2. Determine the enantiomeric excess of the racemic mixture.

Answer. You would expect $[R] = [S] = 50\%$.

$$\omega\% = 100\% ([R] - [S]) / ([R] + [S]) = 100\% (50 - 50) / \\ (50 + 50) = 0\%$$

3. Which isomer is dominant and what is the optical purity of a mixture, of (R)- and (S)-2-bromobutane, whose specific rotation was found to be $-9,2^\circ$? ($[\alpha]_{\text{pure R-sample}} = -23,1^\circ$).

Answer. The negative sign tells indicates that the R enantiomer is the dominant one.

$$\text{Optical purity, } \omega\% = 100 [\alpha]_{\text{mixture}} / [\alpha]_{\text{pure sample}} = \\ = 100 (-9,2) / -23,1 = +40\%.$$

This indicates a 40% excess of R over S.

4. Given that (S)-2-bromobutane has a specific rotation of $+23,1^\circ$ and (R)-2-bromobutane has a specific rotation of $-23,1^\circ$, what is the optical purity and % composition of a mixture whose specific rotation was found to be $+18,4^\circ$?

URL: <http://www.mhhe.com/physsci/chemistry/carey/student/olc/graphics/carey04oc/ch07/others/ch07ans.html>

Answer. The positive sign indicates that the (S)-isomer is in excess.

$$\text{Optical purity, \%} = 100 [\alpha]_{\text{mixture}} / [\alpha]_{\text{pure sample}} = \\ = 100 (+18,4) / +23,1^\circ = 80\%.$$

This indicates a 80% excess of S over R. The 20% left-over, which is optically inactive, must be equal amounts of both (R)- and (S)-bromobutane. The excess 90% is all S so there is a total of 10% (R) and 90% (S).

III. Lab practice.

In this experiment a sugar solution of known concentration (C), but unknown identity will be prepared (note the units of concentration used). The observed rotation (α_{obs}) will be obtained by using a polarimeter. This data will be used to calculate the specific rotation $[\alpha]$ and the identity of the sugar will be hypothesized:

$$[\alpha] = \alpha_{\text{obs}} / (C \cdot l),$$

where $[\alpha]$ = specific rotation of the compound;

α_{obs} = observed rotation of light in degrees;

C = concentration in grams per milliliter (g/ml);

l = cell length in decimeters (dm).

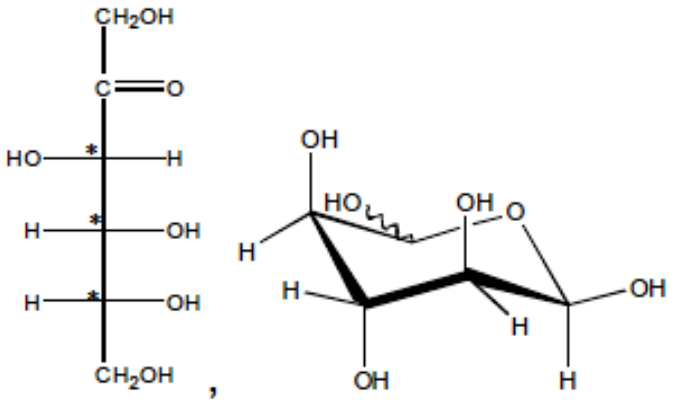
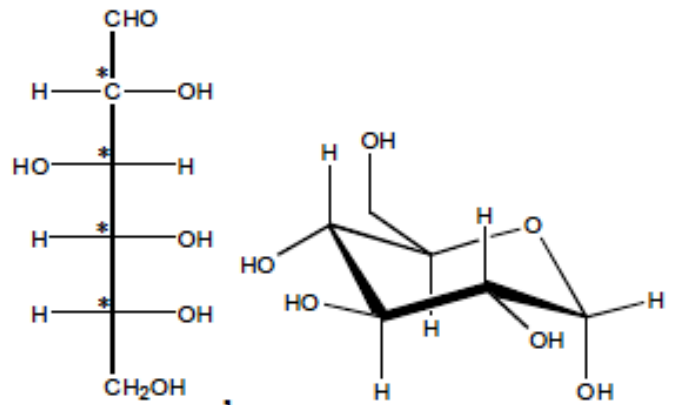
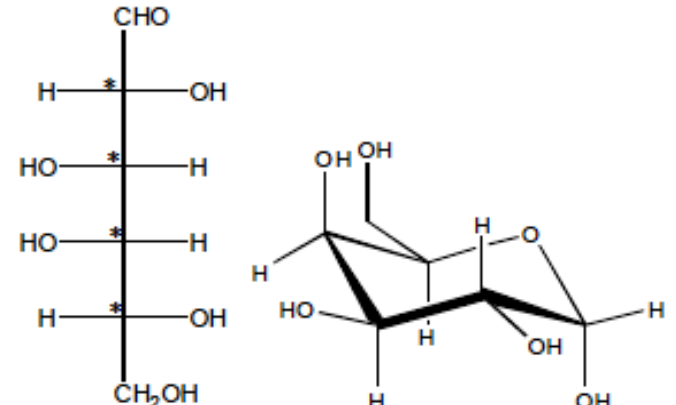
Name	Structure (Fisher, Haworth)	Specific Rotation [α]
D-Fructose	 <p>The Fischer projection of D-fructose shows a five-carbon chain with a ketone group at C2. The chiral centers at C3, C4, and C5 have hydroxyl groups on the left, right, and right sides, respectively. The Haworth projection shows the furanose ring with hydroxyl groups at C2 (up), C3 (down), C4 (up), and C5 (down).</p>	-86
D-Glucose	 <p>The Fischer projection of D-glucose shows a six-carbon chain with an aldehyde group at C1. The chiral centers at C2, C3, and C4 have hydroxyl groups on the right, left, and right sides, respectively. The Haworth projection shows the pyranose ring with hydroxyl groups at C1 (down), C2 (up), C3 (down), C4 (up), and C5 (down).</p>	+98
D-Galactose	 <p>The Fischer projection of D-galactose shows a six-carbon chain with an aldehyde group at C1. The chiral centers at C2, C3, and C4 have hydroxyl groups on the right, right, and left sides, respectively. The Haworth projection shows the pyranose ring with hydroxyl groups at C1 (down), C2 (up), C3 (up), C4 (down), and C5 (down).</p>	+82
Sucrose	Glucose-fructose	+64,5

Sample Preparation, Set Up and Procedure:

1. Weigh out approximately 0,5 g of unknown sample (m). Record all the digits of this mass in your notebook.

2. In 50 ml beaker, dissolve your material in approximately 10 ml of deionized water. Swirl the contents until all of the solid has dissolved.

3. Carefully transfer this solution to a 25 ml volumetric flask. Rinse beaker with approximately 2 ml of deionized water. Transfer this solution to volumetric flask. Repeat.

4. Carefully drop wise add deionized water to volumetric flask until bottom of meniscus is exactly on line. This is your solution.

5. In notebook, calculate the concentration in g/ml.

6. Obtain the α_{obs} by analyzing your solution in the polarimeter using the instructions mounted adjacent to machine and reviewed by your instructor. Repeat the measurement for 3 times.

7. Using the above equation, calculate the specific rotation $[\alpha]$.

8. Select the identity of your material from the list provided.

9. Fill out the relevant spaces in the data table.

Nº	α_{obs}	α_{obs}	l	m	C	$[\alpha]$	Identification result
1							
2							
3							

Conclusion: _____

IV. Self-test:

1. The Pharmacopoeia prescribes determination of the specific rotation $[\alpha]_{\lambda}^t$ for lots of pharmaceuticals. Which of the following equations is correct?

A. $[\alpha]_{\lambda}^t = \frac{100 \cdot \alpha_{\lambda}^t}{1 \cdot \rho_B}$

D. $[\alpha]_{\lambda}^t = \frac{1000 \cdot \alpha_{\lambda}^t}{1 \cdot A_{1\text{cm}}^{1\text{g}/100\text{ml}}}$

B. $[\alpha]_{\lambda}^t = \frac{\alpha_{\lambda}^t}{1 \cdot \rho_B}$

E. $[\alpha]_{\lambda}^t = \frac{100 \cdot \alpha_{\lambda}^t}{1 \cdot \rho_t}$

C. $[\alpha]_{\lambda}^t = \frac{1000 \cdot \alpha_{\lambda}^t}{1 \cdot \rho_B}$

where $[\alpha]_{\lambda}^t$ = specific rotation in 10 dm/kg;

α_{λ}^t = rotation measured at t °C, at wavelength λ ;

l = length of the cell in dm;

ρ_B = mass concentration of substance B in g/0,1 dm;

ρ_t = density of liquid at t °C.

2. Which parts of the polarimeter, if any, should be transposed?

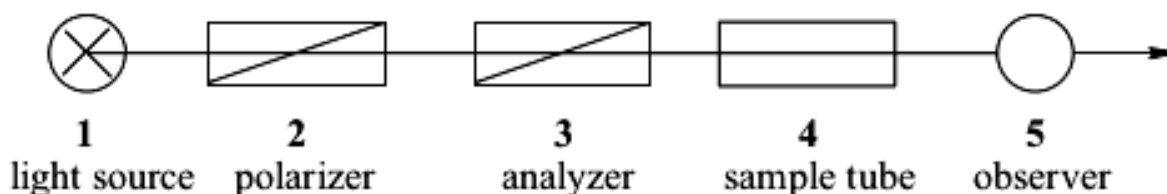

a) 2 and 4

b) 3 and 4

c) 2 and 3

d) 4 and 5

e) the sequence of the parts is correct

3. How many chiral carbon atoms can be found in this molecule?

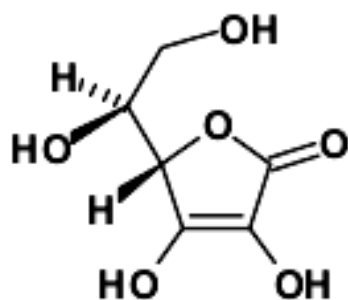

- A. 1
- B. 2
- C. 3
- D. 4
- E. 5

4. The chemical name of apomorphine is:
«(-)-(R)-5,6,6a,7-tetrahydro-10,11-dihydroxy-6-methyl-4H-dibenzo[de,g]quinoline».

What does the (-)-(R) prefix mean in the name?

a) It rotates the plain of polarized light to the left and at the assignment of the absolute configuration the order of the relevant substituents shows counter-clockwise direction.

b) It rotates the plain of polarized light to the left and at the assignment of the absolute configuration the order of the relevant substituents shows clockwise direction.

c) It rotates the plain of polarized light to the right and at the assignment of the absolute configuration the order of the relevant substituents shows counter-clockwise direction.

d) It rotates the plain of polarized light to the right and at the assignment of the absolute configuration the order of the relevant substituents shows clockwise direction.

e) The (R) prefix denotes the racemate form.

5. According to the Eur. Ph. the polarimetry method was used for quality control of pharmaceutical substance Chlo-ramphenicol on indicator «Identification»: 1,50 g of Chlo-ramphenicol was dissolved in 25 ml of ethanol, cell length is 10 sm. Specific rotation must be: $[\alpha]_D^{20}$ from +18,5 to +20,50.

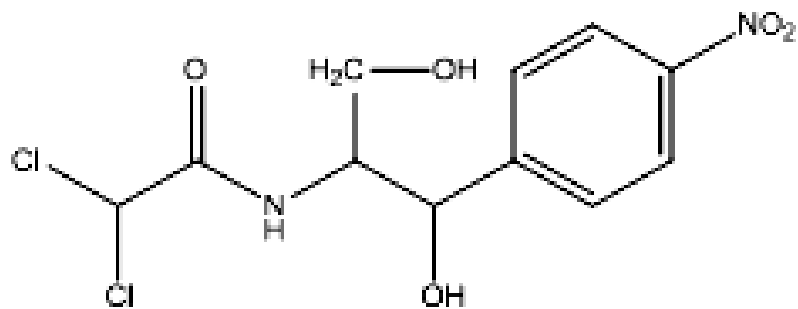

a) Conform the quality of pharmaceutical substance, while the rotational angle of tested sample solution is: $\alpha = +1,20$.

b) Match all the chiral centers in the molecule of Chloramphenicol, determine the number of optic isomers.

Laboratory practice session 5

**OPTICAL METHODS
FOR MEDICINES QUALITY CONTROL.
REFRACTOMETRY**

I. Questions and tasks for discussion:

1. Define refraction.

2. Define refractive index.

3. What is the unit of refractive index?

4. List out the factors on which the refractive index of a medium depends.

5. Define angle of incidence.

6. What is the angle of incidence if a ray of light is incident normal to the surface separating the two media?

7. Find the velocity of the light in a medium having refractive index $n = 2$. Speed of light is 300 000 km/sec.

8. Relative refractive indexes of mediums are $n_{1,2} = 2$; $n_{2,3} = 1,5$. Find $n_{1,3}$.

9. If the ray follows following path while passing from one medium to another, find the refractive index of medium.

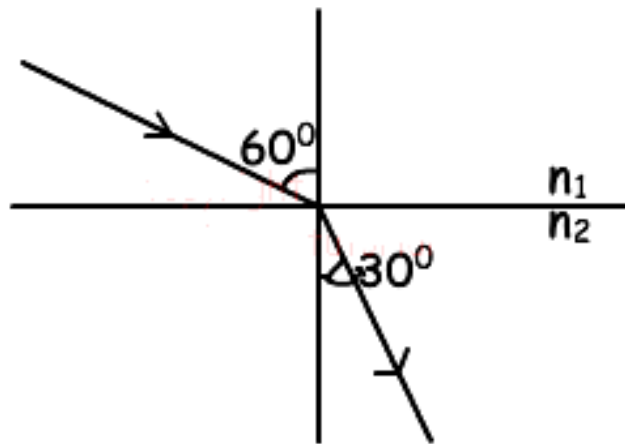

II. Lab practice. Determination of magnesium sulfate aqueous solutions concentration by the means of Abbe type refractometer.

Device of Abbe type refractometer is represented on Fig. 5.1.

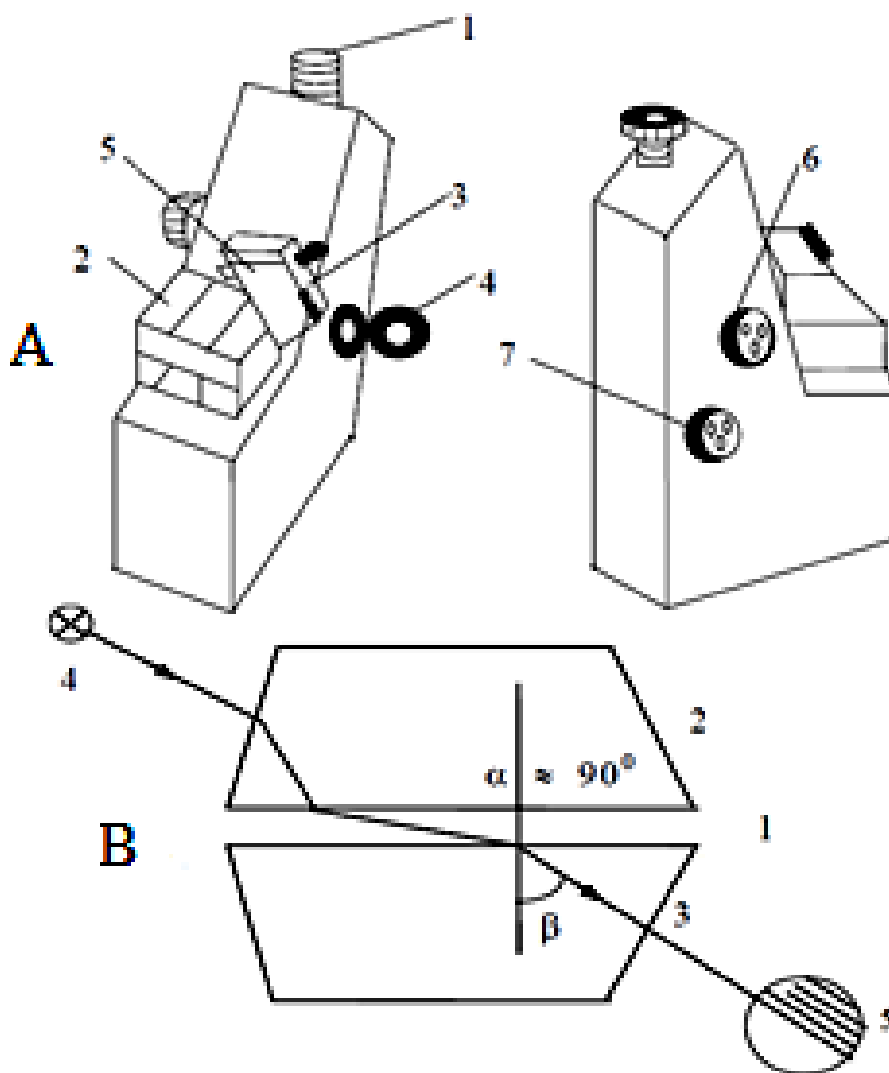

Fig. 5.1:

A – The appearance of refractometer IRF-454:

1 – ocular, 2 –measuring prism, 3 – light prism,

4 – mirror of illumination scale,

5 – mirror of light illuminating prism,

6 – cylinder removing color,

7 – cylinder displacement of the boundary light-shadow;

B – The main working parts of the refractometer:

1 – liquid under investigation, 2 – lighting prism,

3 –measuring prism, 4 – the incident beam, 5 – the field of view

Starting the work carry out the following steps:

1. Open the window of prism block. Rotating the mirrors illuminate the prism with white light.

2. Customize the refractometer with distilled water. To do this, take up the lighting lens, drop 2–3 drops of distilled water on the measuring prism, close the block.

WARNING! Do not touch the surface of a prism with a pipette.

The whole field of the eyepiece should be illuminated uniformly. Unequal illumination, the dark stains on it point to an insufficient amount of introduced liquid.

Rotate the prism to achieve the appearance of dark field in the eyepiece. The appearance of the dark-field corresponds to the position of the prism in which the light beam undergoes internal reflection from the interface between the prism and the test substance. If the border of dark field is not sharp, then rotate compensator until a sharp boundary of dark field appears. Then move dark field boundary to the intersection of lines. Count the value of the refractive index on the scale.

4. Open the box and wipe the prism surface with a soft cloth or filter paper.

5. Place 2–3 drops of the standard solution between the two halves of the prism and tightly compress them. Combine sight buttons with the boundary line separating the light and dark parts of the visual field. Record the scale division of the refractive index, which coincides with the sighting stroke. Measure the refractive index three times for each solution.

Before each subsequent measurement the prism should be thoroughly cleaned with distilled water and then wiped with filter paper.

After measuring the refractive index of 4–5 solutions of magnesium sulfate place the results in Table 5.2.

Plot the dependence of the refractive index n of the solution concentration C (x – values C_i , and Y – values n_i). Don't forget: the value of the refractive index of distilled water = 1,33. Draw a straight line through the data points.

**The measurements results of the refractive indices
of magnesium sulfate solutions**

№	n₁	n₂	n₃	n_{cp}
№ 1. C = ___ %				
№ 2. C = ___ %				
№ 3. C = ___ %				
№ 4. C = ___ %				
№ 5. C _X = X %				

C_i

n_i

Find the value K(F) – the refractive index increment ($dn/dC = \operatorname{tg}\gamma$, where γ – the angle of the slope to the horizontal axis). Substituting the value of K in the formula $n = n_0 + K \cdot C$ find the concentration of the solution № 5:

$$C_x = \frac{n - n_0}{K},$$

where n – refractive index of solution № 5,
 n_0 – refractive index of water.

III. Self-test:

1. Refractometry in pharmaceutical analysis is used for:

- a) identification
- b) purity assessment
- c) assay

2. The basis of refractometry is the law:

- a) of light absorption
- b) of light refraction
- c) of light scattering
- d) of light polarization

3. The ratio of light speed in vacuum to its speed in the medium is called:

- a) the relative refractive index
- b) the absolute refractive index

4. The refractive index depends on:

- a) temperature
- b) the wavelength of light
- c) the length of the cuvette
- d) solution concentration
- e) the nature of the solvent

5. In the method of refractometry the concentration of sample solution is calculated by the formula:

a) $C = \frac{n - n_0}{K}$

b) $C = \frac{n_0 - n}{K}$

c) $C = \frac{n + n_0}{K}$

6. Specify a range of solutions refractive indices, which can be measured in daylight:

- a) 0,2–0,8
- b) 1,3–1,7
- c) 1,8–2,5

7. Designation of the refractive index by symbol n_D^{20} indicates that:

- a) The measurement was performed at 20 °C.
- b) The measurement was performed at the wavelength of the yellow line of the sodium spectrum.
- c) The measurement was performed at a wavelength of the red line of the hydrogen spectrum.
- d) The measurement was performed at a wavelength range of the blue line of hydrogen.
- e) The measurement was performed at wavelength of violet spectral lines hydrogen.

Laboratory practice session 6
**PHARMACOPOEIAL METHODS
FOR WATER QUALITY CONTROL.
METHODS FOR WATER DETERMINATION IN DRUGS**

I. Questions and tasks for discussion:

1. Using pharmacopoeal monographs (Ph. Eur., USP, JP):

a) compare the requirements for «purified water», «water for injection» and procedures for determining their main quality parameters;

b) find out the requirements for the content of aluminum in the water for dialysis and describe the method for aluminum detection.

2. What quality parameters should be daily monitored? What measuring instruments are needed in the lab?

3. Laboratory methods for purified water production: distillation methods, ion exchange, reverse osmosis. Suggest alternative methods for purified water production.

4. Which compounds can be used for K. Fischer reagent standardization?

5. In what cases a residual Karl Fischer titration should be used?

6. Using Internet, find information about the technological and engineering solutions in water treatment systems, pharmaceutical and laboratory water purification systems. Select the appropriate systems suitable for the production of sterile liquid dosage forms.

II. Lab practice:

1. Purified water quality control in accordance with Russian State Pharmacopoeia XII. Using Table 3, develop a certificate of analysis and fill it.

2. Determine the water content by K. Fisher titration in Thrombo ACC®, film coated tablets 100 mg. Fill in the form according to the test results:

Registration List of K. Fischer titration results (volumetric method)			List № (sample ID)
1. Test Sample			
Description (name)	Lot/Batch	Manufac- turer	Number of drug's units for sample preparation
2. Normative Document (ND)			
ND number	ND requirements (norms)		
3. Apparatus			
Description	Model	ID	
Automatic Titra- tor			
Balances			
4. Reagents and Materials			
Description	Lot/Batch	Concentration (titer)	
Solvent			
Karl Fisher rea- gent			

5. Results						
No	Sample weight, g	Titrant volume, ml	Water content, mg	ND norms for water content, mg	RSD, %	Result acceptable (Yes/No)
6. Conclusion						
1. The results meet repeatability requirements (Yes/No)						
2. The sample tested meets ND requirements (Yes/No)						

III. Self-test:

1. On the basis of the reaction between iodine and sulfur dioxide, the KARL-FISCHER method (under appropriate circumstances) is suitable for:

a) Determination of the heavy metal content of a pharmaceutical.

b) Simultaneous measurement of the moisture and crystal water content of a pharmaceutical.

c) Measurement of solvent inclusions.

d) Measurement of the oxygen content of solvents and solutions.

e) Detection and measurement of volatile and oxidizable substances.

2. In water content determination with the KARL FISCHER method, biamperometric end-point detection is most frequently used. Which statements apply to this type of measurements?

a) A double platinum electrode is immersed into the cell.

b) Two electrodes, a platinum and a calomel are immersed into the cell.

c) While water is present in the solution it reacts with the titrant and current flows through the cell.

d) The potential difference between the electrodes is registered as a function of the KARL FISCHER titrant consumption.

e) The current, flowing through the cell is registered as a function of the KARL FISCHER titrant consumption.

Laboratory practice session 7

**CHEMICAL ANALYSIS
FOR MEDICINES QUALITY CONTROL.
PRECIPITATE AND CHROMOGENIC REACTIONS**

I. Questions and tasks for discussion.

1. Fill in the reactions of formation colored hydroxamate compounds for the drugs of different chemical and pharmacological classes:

a) β -Lactams (open lactam ring):

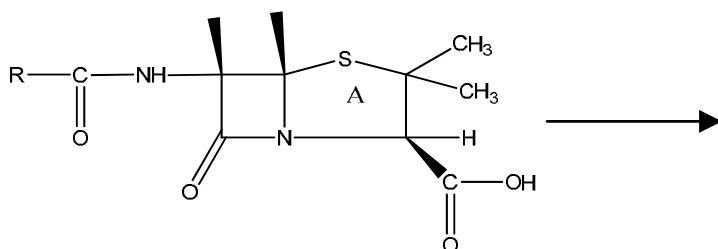

b) cephalosporins (open lactam ring):

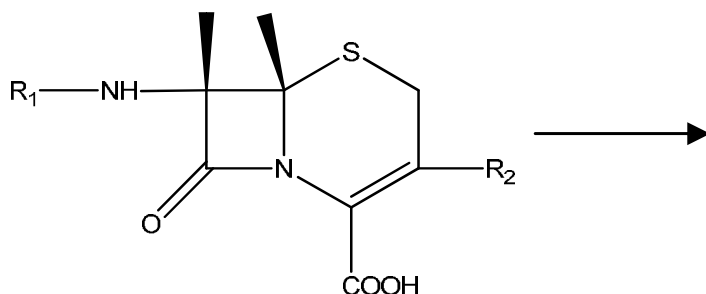

c) corticosteroids (breaking the ester bond):

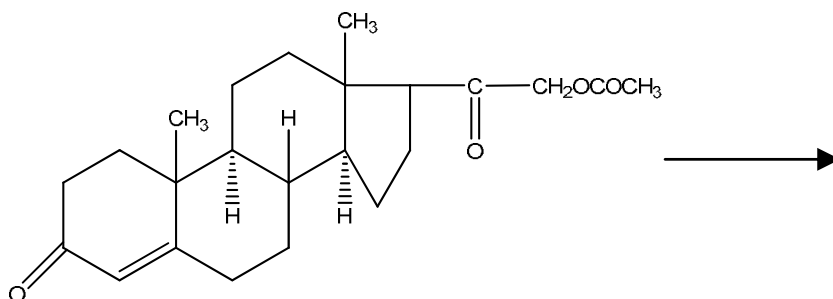

d) derivatives of androgen hormones (breaking the ester bond):

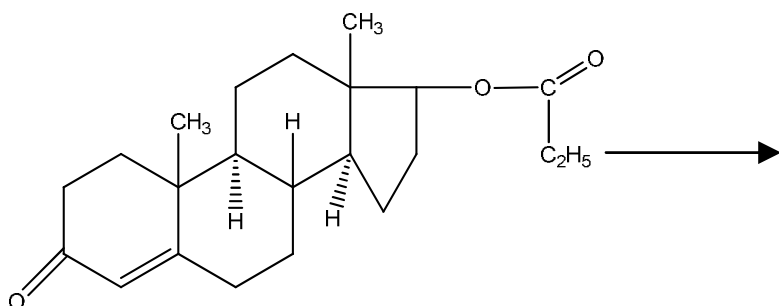

e) aromatic amino acids (breaking the ester bond):

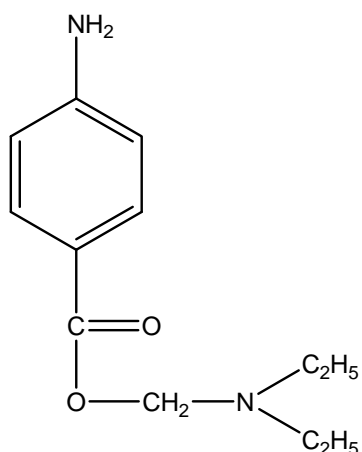

f) Benzopyran derivatives

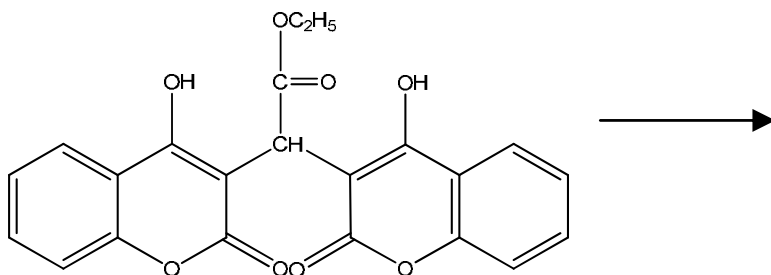

g) Indole derivatives (breaking the amide bond):

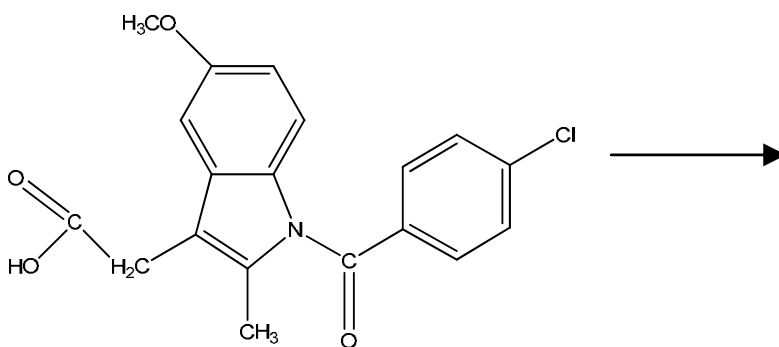

h) pyrimidine derivatives (breaking the amide bond):

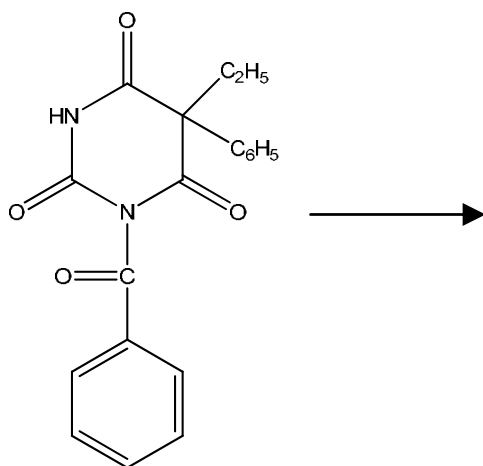

i) 10-acylphenothiazine derivatives (breaking the amide and ester bonds):

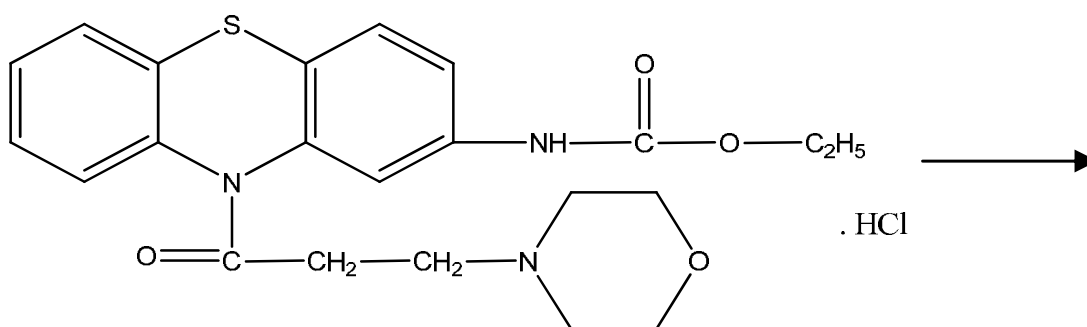

1. Is the reaction of azo dye formation group or specific? Give the definitions. Confirm reply with examples.

2. What pre-conversion reactions are sometimes required before of azo dye formation? Give examples.

3. Name the main steps of azo dye formation process. What is the name of this type reaction?

4. Why does the reaction of aryl diazonium salt forming occur in strongly acidic medium? Write the equation for the reaction, name intermediate products.

5. What is the pH level suitable for azo coupling with aromatic phenols, amines? Write the equation for the reaction.

6. Explain the importance of common group reactions in pharmaceutical analysis on the example of the reaction of azo dye formation.

7. Is the reaction of formation of ferric and copper colored hydroxamate complexes group or specific? Confirm reply with examples.

8. What pre-conversions do the drugs of different pharmacological groups undergo before forming hydroxamate complexes? Give examples.

9. Describe the mechanism for the reaction of formation of ferric and copper colored hydroxamate complexes.

10. Why carboxylic acids cannot be converted to hydroxamic acids by direct interaction with hydroxylamine?

11. What are the mechanisms of reactions with alkaloidal precipitation agents?

12. Give the examples of alkaloidal precipitation agents used in pharmaceutical analysis.

II. Lab practice. Hold the reaction of colored hydroxamate complexes formation for identification one of the carboxylic acid derivatives.

Place a drop of test carboxylic acid solution mixed with 2 drops of saturated ethanol solution of hydroxylamine hydrochloride and 2–3 drops of 0,5 mol/L NaOH in a porcelain crucible and heat. After cooling, add to the mixture 2–3 drops of 0,5 mol/L HCl and a drop of 1% aqueous solution of FeCl₃ or CuSO₄. Observe the resulting color of iron or copper hydroxamate complex salt.

Results registration

Pharmacological group. Drug name	Methodology for analysis	Reaction equation	Analytical effect

Conclusion: analytical effect of iron and copper hydroxamate complexes formation – _____ – confirms the identity of tested drugs of different pharmacological groups to a class of carboxylic acids derivatives. This is a common group reaction.

III. Lab practice. Hold the reaction of azo dye formation for one of the proposed pharmaceutical substances. For the rest drugs just write down the reactions.

Techniques of reactions performance:

1. Aromatic antibiotics – *Chloramphenicol*.

Dissolve about 10 mg of the substance in 1 ml of (50%) ethanol, add 3 ml of 1% solution of calcium chloride and 50 mg of zinc powder. Warm on water bath for 10 minutes. Filter hot solution and then cool it. Add 2 ml of 0,1 mol/L NaNO₂ and 2 ml of the alkaline β-naphthol solution to the filtrate and shake. Observe appearance of purplish-red color or red precipitate.

2. Antibacterial sulfanilamides – *Sulfacetamide sodium*.

Dissolve 1,0 g of substance in 10 ml of water, add 6 mL of dilute acetic acid, filter the mixture. Dissolve precipitate at heating in 1 ml of water; add 3 drops of diluted hydrochloric acid. Add 3 drops of 1% NaNO₂ solution, shake. To the final mixture add 3 ml of alkaline β-naphthol. Cherry-red coloration or orange-red precipitation is observed.

3. Sulfanilamides with diuretic effect – *Furosemide*.

Dissolve 0,1025 g of substance in 10 ml of ethanol. Add 10 mL of 2 mol/L solution of HCl to 1 ml of this solution. Heat in a water bath for 15 minutes, cool. Add 18 ml of NaOH to obtain weakly alkaline pH: solution gives a positive reaction on aromatic amines – a red or purplish-red color of the mixture.

4. Non-steroidal anti-inflammatory drugs – *Phenylbutazone*.

Destruction of pyrazolidine cycle to form benzidine: add 1 ml of glacial acetic acid and 2 ml of HCl to 0.1 g of substance; heat the mixture with reflux condenser for 30 minutes. Cool solution, add 10 ml of water and filter. Add 3 ml of sodium nitrite (7 g/L) to the filtrate. Yellow color appears. To 1 ml of this solution add a solution prepared by dissolving 10 mg of β-naphthol in 5 mL of sodium carbonate. Observe precipitate from red-brown to reddish-purple color.

5. B vitamins – *Folic acid*.

Dissolve 0,01 g of substance in 1 ml of 0,1 mol/L NaOH, add 3 drops of 0,1 mol/l NaNO₂, shake the mixture. Add 3 ml of alkaline β-naphthol: cherry-red color of solution appears.

6. Benzodiazepine tranquilizers – *Fenozepam*.

Acid hydrolysis: heat the mixture containing 0,02 g of substance and 2 ml of diluted HCl to boil during 3 mins, cool it. The solution gives characteristic reaction on primary aromatic amines to produce an orange-red color precipitate.

7. Barbituric acid derivatives – *Phenobarbital*.

Nitrosation: to 0,1 g of substance add 2 ml of concentrated H₂SO₄, 0,3–0,5 g NaNO₂ and heat in a water bath for 10 min. Yellow coloration appears.

Add 10 ml of water and Zn powder to the cooled solution. Filter it after 10–15 min, add 2–3 drops of 2% NaNO₂ the filtrate. Add 3 ml of alkaline β-naphthol: observe cherry-red coloration.

Results registration

Pharmacological group. Drug name	Methodology for analysis	Reaction equation	Analytical effect

Conclusion: analytical effect in the reaction of azo dye formation – _____ – confirms the identity of tested drugs of different pharmacological groups to a class of aromatic amines (phenols). This is a common group reaction.

III. Lab practice. Conduct reaction and write the equation of arylmethane dye formation on the example of the indole derivative – *Reserpine*:

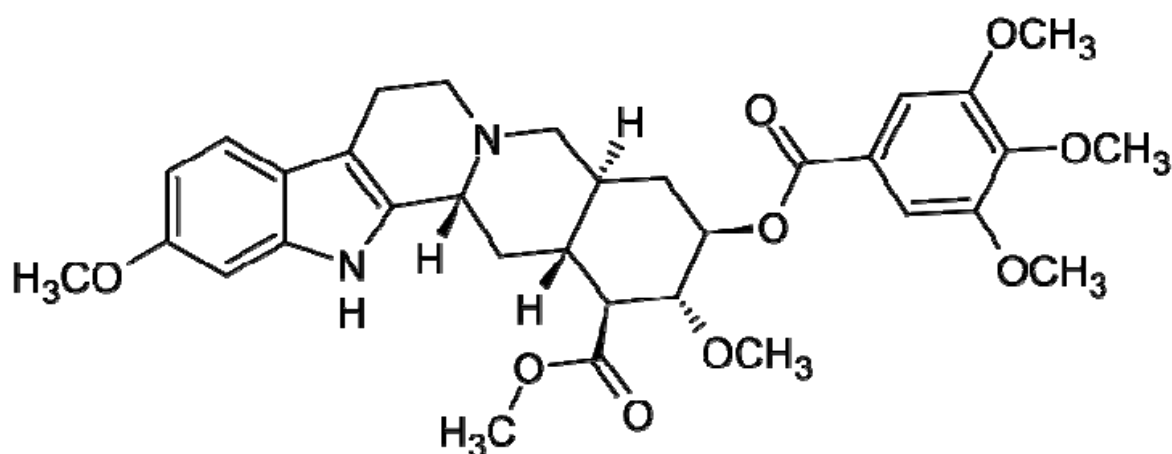

Technique of reaction performance: mix about 0,5 g of pharmaceutical substances with 5 mg dimethylaminobenzaldehyde, 0,2 ml of glacial acetic acid and add 0,2 ml of concentrated sulfuric acid: observe green color appearance. Add 1 ml of glacial acetic acid: color goes into the red.

IV. Conduct and write reactions of colored sediments formation in the interaction of pharmaceutical substances of different chemical and pharmacological classes with alkaloidal precipitation agents:

1. Indole derivatives. Reserpine identification by the determination of melting point of precipitate formed in reaction with ammonium reineckate (Reinecke's salt) – $\text{NH}_4[\text{Cr}(\text{NH}_3)_2(\text{SCN})_4]$ (crystalline powder or dark red crystals).

2. Pyrrole derivatives. Defining authenticity of Lincomycin hydrochloride.

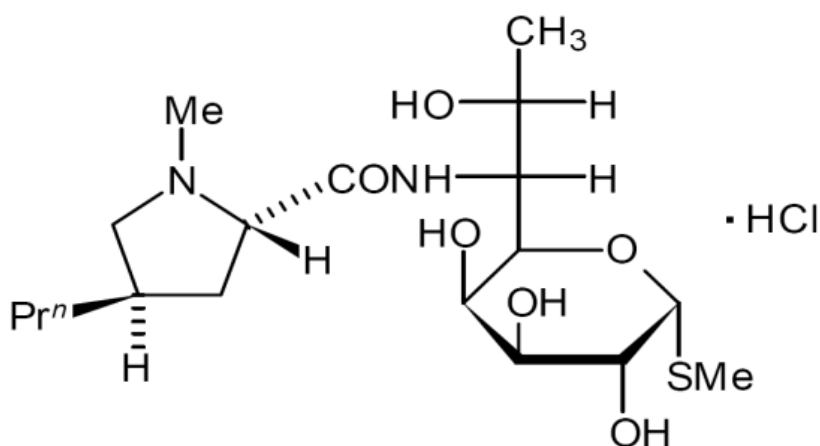

Technique of reaction performance: Dissolve 10 mg of substance in 2 ml of dilute HCl and heat it in a water bath for 3 min. Add 3 ml of Na₂CO₃ and 2% sodium nitroprusside. Observe red-violet color:

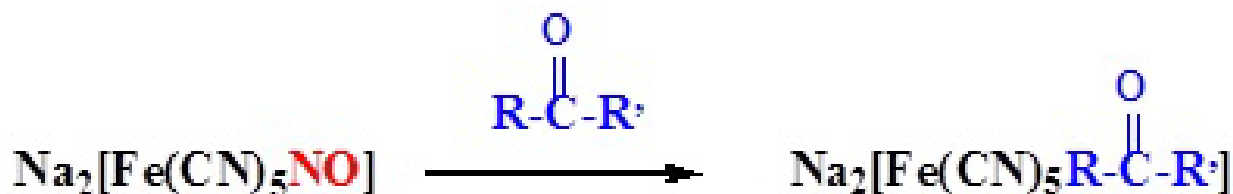

3. Imidazole derivatives. Determine the authenticity of Clonidine hydrochloride.

Technique of reaction performance: to 5 ml of 0.1% solution of clonidine hydrochloride add 6 drops of Dragendorff's reagent – observe an orange precipitate:

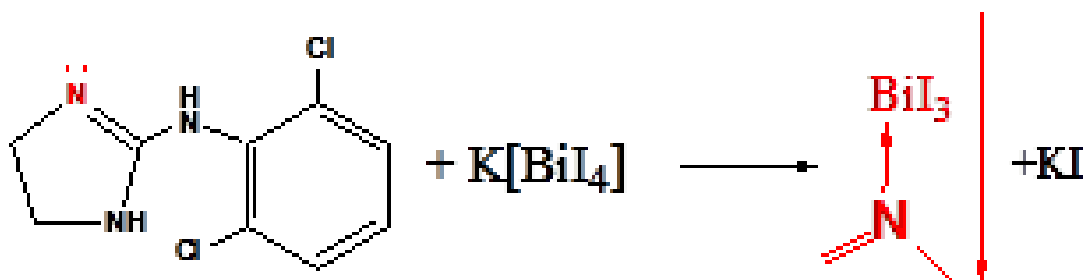

V. Self-test:

1. Advantages of chemical methods of analysis:

- high accuracy
- low detection limit
- visibility
- low threshold drug concentration
- ease of implementation
- availability

2. Analytical signal for chemical analysis:

- a) potential jump on the titration curve
- b) change of the solution color
- c) appearance of luminescence
- d) flame coloration
- e) appearance of spots in the layer of sorbent
- f) gassing

3. Features of the chromogenic reactions:

- a) application of the standard sample
- b) objective approach to the interpretation of chemical reaction results
- c) the massive use of specific reagents
- d) use of clean glassware
- e) application of the control sample
- f) light background for the observation of solution color
- g) dark background for the observation of solution color

4. Qualitative reagent hydroxylamine hydrochloride is characterized by next properties:

- a) oxidant
- b) reducer
- c) $\text{pH} > 7$
- d) $\text{pH} < 7$
- e) participates in reactions of nucleophilic substitution
- f) participates in reactions of electrophilic substitution

5. Mark group of drugs which interacts with hydroxylamine hydrochloride:

- a) aromatic amines
- b) esters
- c) alcohols
- d) amides
- e) lactones
- f) anhydrides

6. Azo dyes are organic molecules that contain one or more groups:

- a) $-\text{NO}_2-$
- b) $-\text{NH}_2$
- c) $-\text{N}=\text{N}-$
- d) $-\text{N}\equiv\text{N}$

7. Choose the most sensitive alkaloidal precipitation reagent:

- a) picric acid
- b) tannin
- c) Dragendorff's reagent
- d) phosphotungstic acid

Laboratory practice session 8

**CHEMICAL ANALYSIS
FOR MEDICINES QUALITY CONTROL.
PHARMACOPOEIAL TITRIMETRIC METHODS**

I. Questions and tasks for discussion:

1. Characterize the requirements to be met by reactions in the titration methods?

2. List the titration methods and approaches for end point determination:

3. What are the different types of titration?

4. What is the difference between the equivalence point and the end-point?

5. What factors affect indicator selection?

6. Benefits of titrimetric methods for the quantitative analysis.

7. Characterize the essence of potentiometric titration.

8. Characterize the essence of the amperometric titration.

9. What is the shape of the amperometric titration curve, if the reaction product is electroactive?

10. What factors affect indicator solvent for titration selection?

11. List the solvents to be used for the quantitative determination of drug substances – weak organic acids.

12. List the solvents to be used for the quantitative determination of drug substances – weak organic bases.

II. Lab practice. Determination of Sulfacetamide in eye drops. Fill in the form according to the results of the test:

Sulfacil potassium determination (assay) in eye drops				
Normative document (ND)_LS-001909-240811 _____				
Testing sample _____				
Batch/Lot _____				
Manufacturer _____				
Limits _____				
Reagents and materials				
1. Burettes				
2. Flasks 100 ml				
3. Pipettes 5, 10 ml				
4. Indicator methylene blue 0,15% aqueous solution				
5. Indicator methyl orange 0,1% in alcohol				
6. Hydrochloric acid 0,100 M (titrant)				
Description of procedure				
5 ml eye drops is placed into a 100 ml volumetric flask and adjusted to the mark by water. 10 ml of this solution is placed in a titration flask of 100 ml, add 2 drops of indicator methylene blue and 2 drops methyl orange & titrate with 0,1 M hydrochloric acid solution to violet staining. In parallel control experiment should be carried out.				
1 ml 0,1 M hydrochloric acid corresponds to 0,02542 g $C_8H_9N_2NaO_3S$ (sulfacil potassium), whose content should be 19,4–20,6%.				

Test results

N^o sample	V (HCl), ml	m (sulfacetamide), g	\bar{m} (sulfacetamide), g	Content, %

Calculations: _____

III. Self-test:

1. For the determination of Streptocide by KBrO_3 titration we need:

- a) bromine
- b) potassium bromate
- c) potassium bromide
- d) sulfuric acid
- e) iodine
- f) sodium thiosulfate
- g) starch solution

2. For argentimetric ethinylestradiol determination next reagents are necessary:

- a) silver nitrate
- b) Ammonium thiocyanate
- c) ferric alum
- d) potassium chromate

3. Chemical reactions used in the titration methods should meet following requirements:

- a) the reaction is irreversible
- b) low rate of reactions
- a) high rate of reactions
- d) reversible reaction
- d) without adverse reactions
- e) required the presence of adverse reactions

4. For the weak organic acids quantitative determination what solvents could be used:

- a) acetone
- b) glacial acetic acid
- c) dimethylformamid
- d) acetic anhydride
- e) ethyl alcohol

5. For the weak organic bases quantitative determination what solvents could be used:

- a) acetone
- b) glacial acetic acid
- c) dimethylformamid
- d) acetic anhydride
- e) ethyl alcohol
- f) anhydrous acetic acid

Laboratory practice session 9

**ULTRAVIOLET (UV)
AND VISIBLE SPECTROPHOTOMETRY
FOR MEDICINES QUALITY CONTROL**

I. Questions and tasks for discussion

1. What are some of the factors that can lead to deviations in Beer's Law and explain why?

2. What factors lead to the absorption of UV/Vis radiation by organic molecules?

3. What is an auxochrome and what affect does it have on UV/Vis spectra and why?

4. Calculate the percentage of stated content of promazine hydrochloride in promazine tablets from following information: tablet powder containing ca 80 mg of promazine hydrochloride is ground to a paste with 10 ml of 2 M HCl. The paste is then diluted with 200 ml of water, shaken for 15 min and finally made up to 500 ml. A portion of the extract is filtered. 5 ml of the filtrate is taken and diluted to 100 ml with 0,1 M HCl. The absorbance is read at a wavelength of 251 nm.

- E (1%, 1 cm) value of promazine, HCl at 251 nm = 395;
- Stated content of promazine, HCl per tablet = 50 mg;
- Weight of 20 tabkets = 1,667 g;
- Weight of tablet powder taken for assay = 0,1356 g;
- Absorbance reading = 0,755.

II. Examine the articles «Absorption spectrophotometry, ultraviolet and visible» from different pharmacopoeias: European, Japanese, International and U.S. Pharmacopoeia. Find similarities and differences in the techniques of spectral analysis. Fill in the table. Make a conclusion about the harmonization degree of these pharmacopoeial articles.

Items of comparison	European Pharmacopoeia	Japanese Pharmacopoeia	International Pharmacopoeia	U.S. Pharmacopoeia
Article title				
Measurement range, nm				

Items of comparison	European Pharmacopoeia	Japanese Pharmacopoeia	International Pharmacopoeia	U.S. Pharmacopoeia
Purpose applications				
Formulas				
Equipment features				
Assay techniques				
Identification techniques				
Conclusion				

III. Lab practice. Spectrophotometric determination of active ingredient in solution of Chlorhexidine 0,05% for external application

Procedure		SPECTROPHOTOMETRIC DETERMINATION OF ACTIVE INGREDIENT IN SOLUTION FOR EXTERNAL APPLICATION		
1. Testing sample				
name				
ID	lot/batch	shelf life	manufac-turer	number of units for testing
2. Normative document (ND)				
3. Reagents and materials				
UV/Vis – spectrophotometer		model, type		ID
quartz cuvette				
labware				
purified water				
4. Description of procedure				
<p>2 ml of the preparation was placed into 100 ml volumetric flask, adjust to the mark with water, mix. Measure resulting solution absorbance by means of spectrophotometer at the peak absorption wavelength of 253 nm in 10 mm cuvette. Use water as reference solution.</p> <p>The content of active ingredient in 1 ml of the solution in g (X) is calculated by the formula:</p> $X = \frac{A \cdot 100}{330 \cdot 2 \cdot 100} = \frac{A}{660}$ <p>where A – absorbance of the test solution; 330 – specific absorption rate of the active substance at the wavelength of 253 nm.</p> <p>Content of active substance in 1 ml of the solution should be from 0,00045 to 0,00055 g</p>				

Test results

Run	Absorbance, (A)	Content (X), g	$X_{\text{mean.}}$, g	ND Limits
1				0,00045–0,00055 g
2				
3				
Calculations:				
Conclusion				
sample meets / does not meet ND requirements				

III. Self-test.

1. Which of the following are the types of the spectrophotometers:

- a) single-beam and tetrad beam spectrophotometers
- b) single-beam and double beam spectrophotometers
- c) only double beam spectrophotometers

2. What is the unit of A in the equation representing Bouguer-Lambert-Beer's law $A = \epsilon \cdot c \cdot l$:

- a) $\text{L mol}^{-1} \text{ cm}^{-1}$
- b) no unit
- c) mol L^{-1}

3. Specific absorbance is:

- a) absorption of 1% solution of analyte in a 1 cm cuvette
- b) dispersion of light through the solution
- c) none of the above is a correct answer

4. The interaction of light and matter could be:

- a) Absorption
- b) emission
- c) Reflection-dispersion

5. Factors which lead to the deviation from Bouguer – Lambert-Beer's law:

- a) concentration of the analyte
- b) interaction of solute with solvent
- c) all the above are correct answers

6. Beer's Law states that:

- a) Absorbance is proportional to both the path length and concentration of the absorbing species.
- b) Absorbance is proportional to the log of the concentration of the absorbing species.
- c) Absorbance is equal to I_0/I .

Laboratory practice session 10
**INFRARED (IR) SPECTROSCOPY
FOR MEDICINES QUALITY CONTROL**

I. Questions and tasks for discussion

1. Compare the purposes of UV/Vis and IR absorption spectroscopy.

2. What type of detectors are used in IR spectroscopy?

3. What types of molecular transitions are associated with IR absorption?

7. The stereoisomers, ephedrine and pseudoephedrine, are precursors for methamphetamine. The gas-phase infrared spectra of these compounds, separated by using GC-IR spectroscopy, are shown in Figure below. From inspection of these spectra, is it possible to differentiate these compounds in a forensic sample obtained from a clandestine laboratory?

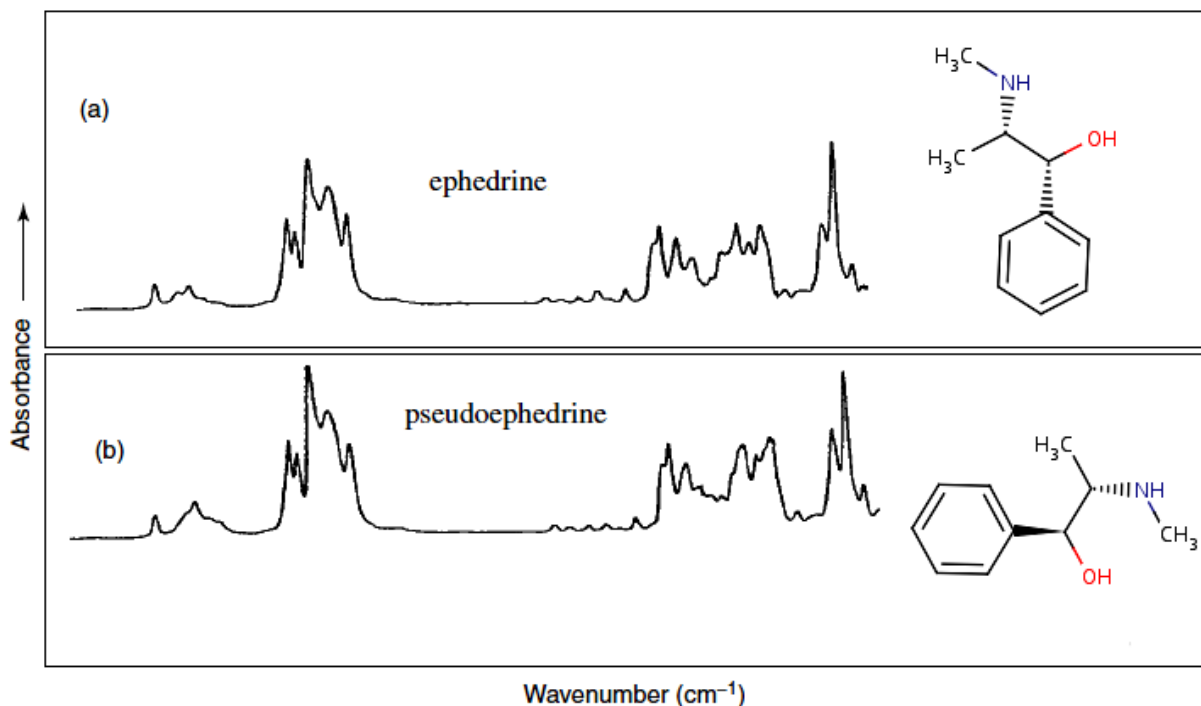

II. Lab practice. Using the example of the analysis of the aspirin IR spectrum (Course book – Topic 10), analyze the proposed by the lecturer IR spectrum of pharmaceutical substance.

Make a table of correlation for represented in the spectrum absorption bands and the functional groups of the molecule:

– put in the table the basic functional groups of the molecule;

– look at the table of main IR frequencies (Appendix 2) and find there frequencies for listed functional groups;

– find the appropriate absorption bands on your spectrum; put in the table their frequencies;

– compare the frequency meanings from your spectrum with the standard figures from the table of main IR frequencies (Appendix 2);

– make a conclusion about the quality of the substance.

Functional group	Standard IR frequencies (Appendix 2)	IR frequencies from the spectrum
Conclusion:		

III. Self-test:

1. What is the relationship between wavelength and wave-number?

- a) Wavenumber = $1/\text{wavelength}$ in centimeters.
- b) Wavenumber = $1/\text{wavelength}$ in nanometers.
- c) Wavelength in nanometers = $1/\text{wavenumber}$.

2. For a molecule to absorb IR, why must the molecule's vibrations cause fluctuations in the dipole moment of the molecule?

- a) Because a change in dipole moment lowers the energy required for electronic transitions.
- b) Because for absorption to occur, the radiation must interact with the electric field caused by changing dipole moment.
- c) Because fluctuations in the dipole moment allow the molecule to deform by bending and stretching.

3. Why are rotational transitions of little use to a spectroscopist?

- a) Because the energy required to induce a rotational transition is so small that it cannot be measured.
- b) Because rotational transitions are extremely rare.
- c) Because, in liquids and solids, spectral lines corresponding to rotational transitions are broadened into a continuum as the result of molecular collisions and other interactions.

4. FT-IR instrument record a signal in the

- a) time domain
- b) frequency domain

5. What does the Michelson interferometer do?

- a) Split a polychromatic beam of radiation into its component wavelengths.
- b) Selectively filter certain wavelengths from a beam of I.R. radiation.
- c) Modulate the I.R. signal at a lower frequency, so that it can be observed by a detector.

6. How do you turn a signal recorded in the time domain into a frequency domain signal?

- a) Fourier transformation.
- b) Measurement of peak areas.
- c) By use of a Michelson interferometer.

7. Which wavenumber range is prescribed by the Pharmacopoeia for IR measurements?

- a) 2,5–15 cm^{-1}
- b) 60–208 cm^{-1}
- c) 206–560 cm^{-1}
- d) 670–4000 cm^{-1}
- e) 3800–6000 cm^{-1}

8. What types of IR-radiation detectors are used in IR-spectrometers?

- a) Nernst glower
- b) Thermocouple
- c) Photoconducting
- d) Pyroelectric
- e) incandescent wire

9. The «fingerprint region» of IR-spectrum is lying in wave-number range

- a) from about 4000 to 3000 cm^{-1}
- b) from about 1500 to 500 cm^{-1}
- c) from about 2500 to 2000 cm^{-1}
- d) from about 11 500 to 4000 cm^{-1}

10. Choose the facts, which characterize near infrared spectroscopy

- a) weak absorption coefficients
- b) strong absorption coefficients
- c) overtones of fundamental molecular vibrations
- d) fundamental molecular vibrations
- e) high penetration depth of radiation

Laboratory practice session 11

**ATOMIC ABSORPTION SPECTROSCOPY (AAS)
FOR MEDICINES QUALITY CONTROL**

I. Questions and tasks for discussion:

1. What are the basic differences between atomic emission and atomic absorption techniques from an instrumental point of view?

2. How do hollow cathode tubes work?

3. Which technique is more sensitive, flame AA or atomic emission spectroscopy and why? (Hint- this is a trick question)

4. What is the purpose of the flame in flame atomic absorption spectroscopy?

5. Why are atomic emission methods with an inductively coupled plasma source better suited for multielement analysis than are flame atomic absorption techniques?

6. Why is the internal standard method often employed in plasma emission spectrometry?

II. Lab practice. Assay of calcium and magnesium in haemodialysis fluid.

The calcium (Ca) and magnesium (Mg) in a haemodialysis solution were analysed using atomic absorption spectrophotometry as follows:

- Standard solutions containing Ca at concentration of 10,7 mg/100 ml of water and containing Mg at a concentration of 11,4 mg/100 ml water were diluted as follows;

– Dilution: 10 ml of both solutions were transferred to the same 100 ml volumetric flask and diluted to 100 ml (diluted standard solution);

– The calibration series was prepared by diluting the diluted standard solution with water as indicated in Table below:

Volume taken for dilution, ml	Final volume, ml	Readings for Ca dilution series	Readings for Mg dilution series
0	100	0,02	0,005
5	100	0,154	0,168
10	100	0,310	0,341
15	100	0,379	0,519
20	100	0,619	0,685
25	100	0,772	0,835

Note:

– The dialysis solution was diluted from 5 to 250 ml before analysis of Ca;

– Atomic absorption reading obtained for Ca = 0,343;

– The dialysis solution was diluted from 10 to 100 ml before analysis of Mg;

– Atomic absorption reading obtained for Mg = 0,554.

Calculate the concentration of Ca and Mg in the dialysis solution in $\text{mmol}\cdot\text{l}^{-1}$.

II. Self-test:

1. Principles of Atomic Absorption Spectroscopy (AAS):

a) Light with specific frequencies is absorbed by different metals when they vaporize in a flame.

b) The energy absorbed excites electrons, moving them from their ground state to a higher energy state.

c) Atomic Absorption Spectroscopy uses hollow cathode lamps to emit light with these frequencies which is then absorbed by the sample containing the metal ion.

d) The amount of light absorbed by the sample is compared to the amount of light absorbed by a set of standards of known concentration.

2. Which statement about Atomic Absorption Spectroscopy (AAS) is correct?

a) AAS is an effective qualitative technique but it cannot be used for quantitative analysis.

b) AAS measures the wavelengths of light emitted when electrons fall back to their ground state.

c) In AAS, white light is shone through a vaporised sample in order to observe which wavelengths are absorbed.

d) The wavelength of light used in AAS matches one of the spectral lines produced when the sample is analysed by a flame test.

3. Atomic Absorption Spectroscopy can be used to measure the concentration of metals in:

a) mining operations and in the production of alloys as a test for purity

b) contaminated water, especially heavy metal contamination in industrial waste water

c) organisms, such as mercury in fish

d) pharmaceutical substances

4. Match the pictures and the type of absorption:

1) Molecular absorption band.

2) Atomic absorption band.

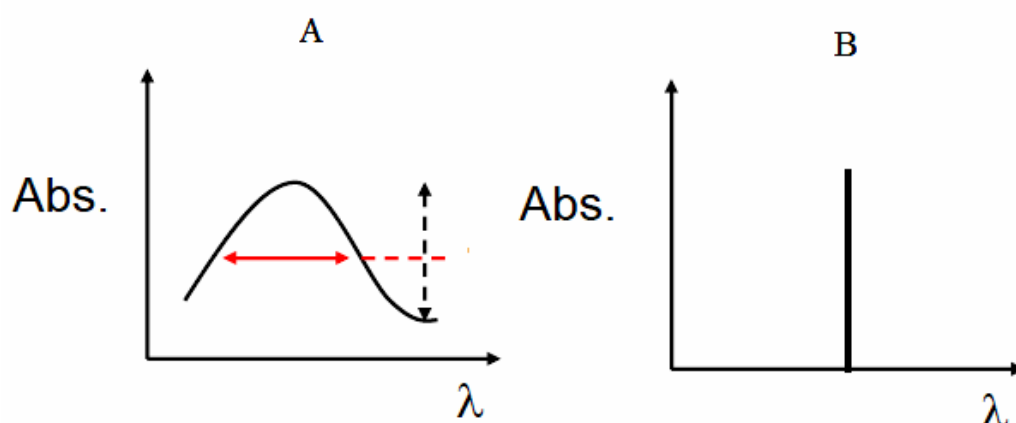

REFERENCES AND FURTHER READING

1. The European Pharmacopoeia. – 9th ed. – France, 2016. – 3978 p.
2. The Japanese Pharmacopoeia. – 17th ed. – Japan, 2016. – 2618 p.
3. The United States Pharmacopoeia USP 42-NF 37. – Toronto, 2019. – 3539 p.
4. *Barton F.E.* Theory and principles of near infrared spectroscopy// Spectroscopy Europe. – 2002. – Vol. 14. – № 1. – P. 12–18.
5. *Burns D.A., Ciurczak E.W.* Handbook of Near-Infrared Analysis. – 3^d ed., revised and expanded // Practical Spectroscopy Series. – Vol. 27. – N. Y.: Marcel Decker, 2008. – 814 p.
6. *Gabbott P.* Principles and Applications of Thermal Analysis. – 1st ed. – Wiley-Blackwell, 2008 – 464p.
7. *Khopkar S.M.* Basic concepts of analytical chemistry. – New Age International (P) Limited, 2017. – 632 p.
8. *Meier P.C., Zund R.E.* Statistical methods in analytical chemistry. – Canada: John Wiley & Sons, INC, 2005. – 456 p.
9. *McPolin O.* Validation of analytical methods for pharmaceutical analysis. – UK: Mourne Training Services, 2009. – 141 p.
10. *Stuart B.* Infrared spectroscopy: fundamentals and applications. – UK: John Wiley & Sons, Ltd, 2004. – 203 p.
11. *Watson D.G.* Pharmaceutical analysis. A textbook for pharmacy students and pharmaceutical chemists. – 3rd ed. – Elsevier Ltd, 2012. – 414 p.
12. Wilson and Gisvold's textbook of organic medicinal and pharmaceutical chemistry / ed. by J.M. Beale, Jr.J.H. Block, W. Kluwer. – 12th ed. – Lippincott Williams & Wilkins, 2011. – 1010 p.

WEBSITES

1. Analytical Procedure Development and Revision of Q2 (R1) Analytical Validation. – URL: <https://www.ich.org/products/guidelines/quality/quality-single/article/validation-of-analytical-procedures-text-and-methodology.html>

2. European Medicines Agency. – URL: https://www.ema.europa.eu/en/documents/scientific-guideline/ich-q-2-r1-validation-analytical-procedures-text-methodology-step-5_en.pdf
3. Pharmacopoeial Harmonisation. – URL: <https://www.edqm.eu/en/international-harmonisation-614.html>
4. Promoting the Quality of Medicines (PQM) program, funded by USAID and implemented by USP. – URL: <http://www.usp.org>
5. TOXNET Toxicology Data Network. – URL: <https://toxnet.nlm.nih.gov>
6. U.S. National Library of Medicine. – URL: <https://pubchem.ncbi.nlm.nih.gov>

PHARMACOPOEIA ARTICLES FOR PEER REVIEW

EUROPEAN PHARMACOPOEIA 6.0

I. 2.4.13. Sulphates (Eur. Ph. 6)

All solutions used for this test must be prepared with distilled water R. Add 3 ml of a 250 g/l solution of barium chloride R to 4,5 ml of sulphate standard solution (10 ppm SO₄) R1. Shake and allow to stand for 1 min. To 2,5 ml of this solution, add 15 ml of the solution to be examined and 0,5 ml of acetic acid R. Prepare a standard in the same manner using 15 ml of sulphate standard solution (10 ppm SO₄) R instead of the solution to be examined. After 5 min, any opalescence in the test solution is not more intense than that in the standard.

II. Not provided

III. 2.4.14. Sulphated Ash (Eur. Ph. 6)

Ignite a suitable crucible (for example, silica, platinum, porcelain or quartz) at $600 \pm 50^{\circ}\text{C}$ for 30 min, allow to cool in a desiccator over silica gel or other suitable desiccant and weigh. Place the prescribed amount of the substance to be examined in the crucible and weigh. Moisten the substance to be examined with a small amount of sulphuric acid R (usually 1 ml) and heat gently at as low a temperature as practicable until the sample is thoroughly charred. After cooling, moisten the residue with a small amount of sulphuric acid R (usually 1 ml), heat gently until white fumes are no longer evolved and ignite at $600 \pm 50^{\circ}\text{C}$ until the residue is completely incinerated. Ensure that flames are not produced at any time during the procedure.

Allow the crucible to cool in a desiccator over silica gel or other suitable desiccant, weigh it again and calculate the percentage of residue. If the amount of the residue so obtained exceeds the prescribed limit, repeat the moistening with sulphuric acid R and ignition, as previously, for 30 min periods until 2 consecutive weightings do not differ by more than 0,5 mg or until the percentage of residue complies with the pre-

scribed limit. The amount of substance used for the test (usually 1–2 g) is chosen so that at the prescribed limit the mass of the residue (usually about 1 mg) can be measured with sufficient accuracy.

IV. 2.2.32. Loss on drying (Eur. Ph. 6)

Loss on drying is the loss of mass expressed as per cent m/m.

Method. Place the prescribed quantity of the substance to be examined in a weighing bottle previously dried under the conditions prescribed for the substance to be examined. Dry the substance to constant mass or for the prescribed time by one of the following procedures. Where the drying temperature is indicated by a single value rather than a range, drying is carried out at the prescribed temperature ± 2 °C.

a) «in a desiccator»: the drying is carried out over diphosphorus pentoxide R at atmospheric pressure and at room temperature;

b) «in vacuo»: the drying is carried out over diphosphorus pentoxide R, at a pressure of 1,5 to 2,5 kPa at room temperature;

c) «in vacuo within a specified temperature range»: the drying is carried out over diphosphorus pentoxide R, at a pressure of 1,5 to 2,5 kPa within the temperature range prescribed in the monograph;

d) «in an oven within a specified temperature range»: the drying is carried out in an oven within the temperature range prescribed in the monograph;

e) «under high vacuum»: the drying is carried out over diphosphorus pentoxide R at a pressure not exceeding 0,1 kPa, at the temperature prescribed in the monograph.

If other conditions are prescribed, the procedure to be used is described in full in the monograph.

V. Loss on ignition – in Monograph

MANGANESE SULPHATE

MONOHYDRATE

(Eur. Ph. 6)

Mangani sulfas monohydricus

$\text{MnSO}_4 \cdot \text{H}_2\text{O}$ Mr 169,0

[10034-96-5]

DEFINITION

Content: 99,0 per cent to 101,0 per cent (ignited substance).

CHARACTERS

Appearance: pale pink crystalline powder, slightly hygroscopic.
Solubility: freely soluble in water, practically insoluble in ethanol (96 per cent).

IDENTIFICATION

a) Solution S (see Tests) gives reaction (a) of sulphates (2.3.1).

b) Dissolve 50 mg in 5 ml of water R. Add 0,5 ml of ammonium sulphide solution R. A pale pink precipitate is formed which dissolves on the addition of 1 ml of anhydrous acetic acid R.

c) Loss on ignition (see Tests).

TESTS

Solution S. Dissolve 10,0 g in distilled water R and dilute to 100 ml with the same solvent.

Appearance of solution. Solution S is not more opalescent than reference suspension II (2.2.1).

Chlorides (2.4.4): maximum 100 ppm. Dilute 5 ml of solution S to 15 ml with water R.

Iron (2.4.9): maximum 10 ppm, determined on solution S.

Zinc: maximum 50 ppm. To 10 ml of solution S add 1 ml of sulphuric acid R and 0,1 ml of potassium ferrocyanide solution R. After 30 s, any opalescence in the solution is not more intense than that in a mixture of 5 ml of zinc standard solution (10 ppm Zn) R, 5 ml of water R, 1 ml of sulphuric acid R and 0,1 ml of potassium ferrocyanide solution R.

Heavy metals (2.4.8): maximum 20 ppm.

12 ml of solution S complies with test A. Prepare the reference solution using lead standard solution (2 ppm Pb) R.

Loss on ignition: 10,0 per cent to 12,0 per cent, determined on 1,00 g at 500 ± 50 °C.

ASSAY

Dissolve 0,150 g in 50 ml of water R. Add 10 mg of ascorbic acid R, 20 ml of ammonium chloride buffer solution pH 10,0 R and 0,2 ml of a 2 g/l solution of mordant black 11 R in triethanolamine R. Titrate with 0,1 M sodium edetate until the colour changes from violet to pure blue. 1 ml of 0,1 M sodium edetate is equivalent to 15,10 mg of MnSO_4 .

JAPANESE PHARMACOPOEIA

I. 1.14 Sulfate Limit Test (JP XV)

Sulfate Limit Test is a limit test for sulfate contained in drugs. In each monograph, the permissible limit for sulfate (as SO_4) is described in terms of percentage (%) in parentheses.

Procedure. Unless otherwise specified, transfer the quantity of the sample, directed in the monograph, to a Nessler tube, dissolve it in sufficient water, and add water to make 40 mL. Add 1 mL of dilute hydrochloric acid and water to make 50 mL, and use this solution as the test solution.

Transfer the volume of 0,005 mol/L sulfuric acid VS, directed in the monograph, to another Nessler tube, add 1 mL of dilute hydrochloric acid and water to make 50 mL, and use this solution as the control solution.

When the test solution is not clear, filter both solutions according to the same procedure. Add 2 mL of barium chloride TS to the test solution and to the control solution, mix well, and allow to stand for 10 min. Compare the white turbidity produced in both solutions against a black background by viewing downward or transversely. The turbidity produced in the test solution is not thicker than that of the control solution.

II. 1.15 Readily Carbonizable Substances Test (JP XV)

Readily Carbonizable Substances Test is a method to examine the minute impurities contained in drugs, which are readily colored by addition of sulfuric acid.

Procedure. Before use, wash the Nessler tubes thoroughly with sulfuric acid for readily carbonizable substances. Unless otherwise specified, proceed as follows. When the sample is solid, place 5 mL of sulfuric acid for readily carbonizable substances in a Nessler tube, to which add a quantity of the finely powdered sample, little by little, as directed in the monograph, and dissolve it completely by stirring with a glass rod. When the sample is liquid, transfer a volume of the sample, as directed in the monograph, to a Nessler tube, add 5 mL of sulfuric acid for readily carbonizable substances, and mix by shaking. If the temperature of the content of the tube rises, cool the content; maintain it at the standard temperature, if the reaction may be affected by the temperature. Allow to stand for 15 min, and compare the color of the liquid with that of the matching fluid in the Nessler

tube specified in the monograph, by viewing transversely against a white background.

III. 2.44 Residue on Ignition Test (JP XV)

This test is harmonized with the Sulphated Ash Test of the European Pharmacopoeia and the Residue on Ignition Test of the U.S. Pharmacopoeia. The parts of the text that are not harmonized are marked with symbols (***)).

The Residue on Ignition Test is a method to measure the amount of residual substance not volatilized from a sample when the sample is ignited in the presence of sulfuric acid according to the procedure described below. This test is usually used for determining the content of inorganic impurities in an organic substance.

The description, for example, «not more than 0,1% (1 g)», in a monograph, indicates that the mass of the residue is not more than 1 mg per 1 g of the substance in the test in which about 1 g of the substance is weighed accurately and ignited by the procedure described below, and «after drying» indicates that the sample is tested after being dried under the conditions specified in the test for Loss on drying.

Procedure. Ignite a suitable crucible (for example, silica, platinum, quartz or porcelain) at 600 ± 500 °C for 30 min, cool the crucible in a desiccator (silica gel or other suitable desiccant) and weigh it accurately.

Take the amount of test sample specified in the individual monograph in the crucible and weigh the crucible accurately.

Moisten the sample with a small amount (usually 1 mL) of sulfuric acid, then heat gently at a temperature as low as practicable until the sample is thoroughly charred. After cooling, moisten the residue with a small amount (usually 1 mL) of sulfuric acid, heat gently until white fumes are no longer evolved, and ignite at 600 ± 500 until the residue is completely incinerated. Ensure that flames are not produced at any time during the procedure. Cool the crucible in a desiccator (silica gel or other suitable desiccant), weigh accurately and calculate the percentage of residue.

Unless otherwise specified, if the amount of the residue so obtained exceeds the limit specified in the individual monograph, repeat the moistening with sulfuric acid, heating and ignition as before, using a 30-minute ignition period, until two consecutive weightings of the residue do not differ by more than 0,5 mg or until the percentage of residue complies with the limit in the individual monograph.

IV. 2.41. Loss on Drying Test (JP XV)

Loss on Drying Test is a method to measure the loss in mass of the sample, when dried under the conditions specified in each monograph. This method is applied to determine the amount of water, all or a part of water of crystallization, or volatile matter in the sample, which is removed during the drying.

The description, for example, «not more than 1,0% (1 g, 105 °C, 4 hours)» in a monograph, indicates that the loss in mass is not more than 10 mg per 1 g of the substance in the test in which about 1 g of the substance is accurately weighed and dried at 105 °C for 4 hours, and «not more than 0,5% (1 g, in vacuum, phosphorus (V) oxide, 4 hours)», indicates that the loss in mass is not more than 5 mg per 1 g of the substance in the test in which about 1 g of the substance is accurately weighed, transferred into a desiccator (phosphorus (V) oxide), and dried in vacuum for 4 hours.

Procedure. Weigh accurately a weighing bottle that has been dried for 30 min according to the method specified in the monograph. Take the sample within the range of $\pm 10\%$ of the amount directed in the monograph, transfer into the weighing bottle, and, unless otherwise specified, spread the sample so that the layer is not thicker than 5 mm, then weigh it accurately. Place the loaded bottle in a drying chamber, and dry under the conditions specified in the monograph. When the size of the sample is large, convert it to small particles having a size not larger than 2 mm in diameter by quick crushing, and use the crushed sample for the test. After drying, remove from the drying chamber, and reweigh accurately. When the sample is dried by heating, the temperature is within the range of ± 20 °C of that directed in the monograph and, after drying the bottle, the sample is allowed to cool in a desiccator (silica gel) before weighing. If the sample melts at a temperature lower than that specified in the monograph, expose the sample for 1 to 2 hours to a temperature between 50 and 100 °C below the melting temperature, dry under the conditions specified in the monograph. Use a desiccant specified in the monograph, and renew frequently.

V. 2.43. Loss on Ignition Test (JP XV)

Loss on Ignition Test is a method to measure the loss in mass when the sample is ignited under the conditions specified in each monograph. This method is usually applied to inorganic drugs which lose a part of the components or impurities during ignition.

The description, for example, «40,0–52,0% (1 g, 450–550 °C, 3 hours)» in a monograph, indicates that the loss in mass is 400 to 520 mg per g of the substance in the test in which about 1 g of the substance is weighed accurately and ignited between 450 and 550 °C for 3 hours.

Procedure. Previously ignite a crucible or a dish of platinum, quartz or porcelain to constant mass, at the temperature directed in the monograph, and weigh accurately after cooling. Take the sample within the range of $\pm 10\%$ of the amount directed in the monograph, transfer into the above ignited container, and weigh it accurately. Ignite under the conditions directed in the monograph, and, after cooling, reweigh accurately. Use a desiccator (silica gel) for the cooling.

UNITED STATES PHARMACOPOEIA

I. 221. CHLORIDE AND SULFATE (USP 30)

The following limit tests are provided as general procedures for use where limits for chloride and sulfate are specified in the individual monographs. Perform the tests and the controls in glass cylinders of the same diameter and matched as closely as practicable in other respects (see Visual Comparison under Spectrophotometry and Light-Scattering 851). Use the same quantities of the same reagents for both the solution under test and the control solution containing the specified volume of chloride or sulfate. If, after acidification, the solution is not perfectly clear, pass it through a filter paper that gives negative tests for chloride and sulfate. Add the precipitant, silver nitrate TS or barium chloride TS as required, to both the test solution and the control solution in immediate sequence. Where the individual monograph calls for applying the test to a specific volume of a solution of the substance, and the limit for chloride or sulfate corresponds to 0,20 mL or less of 0,020 N hydrochloric acid or sulfuric acid, respectively, apply the test to the solution without further dilution. In such cases maintain the same volume relationships for the control solution as specified for the solution under test. In applying the test to the salts of heavy metals, which normally show an acid reaction, omit the acidification and do not neutralize the solution. Dissolve bismuth salts in a few mL of water and 2 mL of nitric acid before treating with the precipitant.

Chloride—Dissolve the specified quantity of the substance under test in 30 to 40 mL of water, or, where the substance is already in solution, add water to make a total volume of 30 to 40 mL, and, if necessary, neutralize the solution with nitric acid to litmus. Add 1 mL each of nitric acid and of silver nitrate TS and sufficient water to make 50 mL. Mix, and allow to stand for 5 minutes protected from direct sunlight. Unless otherwise specified in the monograph, compare the turbidity, if any, with that produced in a solution containing the volume of 0,020 N hydrochloric acid specified in the monograph.

Sulfate—Dissolve the specified quantity of the substance under test in 30 to 40 mL of water, or, where the substance is already in solution, add water to make a total volume of 30 to 40 mL, and, if necessary, neutralize the solution with hydrochloric acid to litmus. Add 1 mL of 3 N hydrochloric acid, 3 mL of barium chloride TS, and sufficient water to make 50 mL. Mix, and allow to stand for 10 min. Unless otherwise specified in the monograph, compare the turbidity, if any, with that produced in a solution containing the volume of 0,020 N sulfuric acid specified in the monograph.

II. 271. READILY CARBONIZABLE SUBSTANCES TEST (USP 30)

In tests for readily carbonizable substances, unless otherwise directed, add the specified quantity of the substance, finely powdered if in solid form, in small portions to the comparison container, which is made of colorless glass resistant to the action of sulfuric acid and contains the specified volume of sulfuric acid TS (see under Test Solutions).

Stir the mixture with a glass rod until solution is complete, allow the solution to stand for 15 min, unless otherwise directed, and compare the color of the solution with that of the specified matching fluid in a comparison container, which also is of colorless glass and has the same internal and cross-section dimensions, viewing the fluids transversely against a background of white porcelain or white glass.

When heat is directed in order to effect solution of the substance in the sulfuric acid TS, mix the sample and the acid in a test tube, heat as directed, and transfer the solution to the comparison container for matching with the designated Matching Fluid.

Special attention is directed to the importance of the concentration of sulfuric acid used in this test. The reagent of the required

strength, i.e., $95,0 \pm 0,5$ percent of H_2SO_4 , is designated as a «Test Solution.»

III. 281. RESIDUE ON IGNITION (USP 30)

Portions of this general chapter have been harmonized with the corresponding texts of the European Pharmacopoeia and the Japanese Pharmacopoeia. The portions that are not harmonized are marked with symbols (***) . The harmonized texts of these pharmacopoeias are therefore interchangeable, and the methods of the European Pharmacopoeia and/or the Japanese Pharmacopoeia may be used for demonstration of compliance instead of the present United States Pharmacopoeia general chapter. These pharmacopoeias have undertaken not to make any unilateral change to this harmonized chapter.

The Residue on Ignition/Sulfated Ash test uses a procedure to measure the amount of residual substance not volatilized from a sample when the sample is ignited in the presence of sulfuric acid according to the procedure described below. This test is usually used for determining the content of inorganic impurities in an organic substance.

Procedure – Ignite a suitable crucible (for example, silica, platinum, quartz, or porcelain) at 600 ± 50 for 30 minutes, cool the crucible in a desiccator (silica gel or other suitable desiccant), and weigh it accurately. Weigh accurately 1 to 2 g of the substance, or the amount specified in the individual monograph, in the crucible. Moisten the sample with a small amount (usually 1 mL) of sulfuric acid, then heat gently at a temperature as low as practicable until the sample is thoroughly charred. Cool; then, unless otherwise directed in the individual monograph, moisten the residue with a small amount (usually 1 mL) of sulfuric acid; heat gently until white fumes are no longer evolved; and ignite at 600 ± 50 , unless another temperature is specified in the individual monograph, until the residue is completely incinerated. Ensure that flames are not produced at any time during the procedure. Cool the crucible in a desiccator (silica gel or other suitable desiccant), weigh accurately, and calculate the percentage of residue. Unless otherwise specified, if the amount of the residue so obtained exceeds the limit specified in the individual monograph, repeat the moistening with sulfuric acid, heating and igniting as before, using a 30-minute ignition period, until two consecutive weighings of the residue do not differ by more than 0,5 mg

or until the percentage of residue complies with the limit in the individual monograph. Conduct the ignition in a well-ventilated hood, but protected from air currents, and at as low a temperature as is possible to effect the complete combustion of the carbon. A muffle furnace may be used, if desired, and its use is recommended for the final ignition at 600 ± 50 .

Calibration of the muffle furnace may be carried out using an appropriate digital temperature meter and a working thermocouple probe calibrated against a standard thermocouple traceable to the National Institute of Standards and Technology. Verify the accuracy of the measuring and controlling circuitry of the muffle furnace by checking the positions in the furnace at the control set point temperature of intended use. Select positions that reflect the eventual method of use with respect to location of the specimen under test. The tolerance is ± 25 at each position measured.

IV. 731. LOSS ON DRYING (USP 30)

The procedure set forth in this chapter determines the amount of volatile matter of any kind that is driven off under the conditions specified. For substances appearing to contain water as the only volatile constituent, the procedure given in the chapter, Water Determination 921, is appropriate, and is specified in the individual monograph.

Mix and accurately weigh the substance to be tested, and, unless otherwise directed in the individual monograph, conduct the determination on 1 to 2 g. If the test specimen is in the form of large crystals, reduce the particle size to about 2 mm by quickly crushing. Tare a glass topped, shallow weighing bottle that has been dried for 30 min under the same conditions to be employed in the determination. Put the test specimen in the bottle, replace the cover, and accurately weigh the bottle and the contents. By gentle, sidewise shaking, distribute the test specimen as evenly as practicable to a depth of about 5 mm generally, and not more than 10 mm in the case of bulky materials. Place the loaded bottle in the drying chamber, removing the stopper and leaving it also in the chamber. Dry the test specimen at the temperature and for the time specified in the monograph. [NOTE – The temperature specified in the monograph is to be regarded as being within the range of ± 2 of the stated figure.] Upon opening the chamber, close the bottle promptly, and allow it to come to room temperature in a desiccator before weighing.

If the substance melts at a lower temperature than that specified for the determination of Loss on drying, maintain the bottle with its contents for 1 to 2 hours at a temperature 5 to 10 below the melting temperature, then dry at the specified temperature.

Where the specimen under test is Capsules, use a portion of the mixed contents of not fewer than 4 capsules.

Where the specimen under test is Tablets, use powder from not fewer than 4 tablets ground to a fine powder.

Where the individual monograph directs that loss on drying be determined by thermogravimetric analysis, a sensitive electrobalance is to be used.

Where drying in vacuum over a desiccant is directed in the individual monograph, a vacuum desiccator or a vacuum drying pistol, or other suitable vacuum drying apparatus, is to be used.

Where drying in a desiccator is specified, exercise particular care to ensure that the desiccant is kept fully effective by frequent replacement.

Where drying in a capillary-stoppered bottle in vacuum is directed in the individual monograph, use a bottle or tube fitted with a stopper having a $225 \pm 25 \mu\text{m}$ diameter capillary, and maintain the heating chamber at a pressure of 5 mm or less of mercury. At the end of the heating period, admit dry air to the heating chamber, remove the bottle, and with the capillary stopper still in place allow it to cool in a desiccator before weighing.

V. Loss on ignition – in Monograph

Manganese Sulfate
(USP 30)

$\text{MnSO}_4 \cdot \text{H}_2\text{O}$ Mr 169,02

Sulfuric acid, manganese(2⁺) salt (1:1) monohydrate.

Manganese(2⁺) sulfate (1:1) monohydrate [10034-96-5].

Anhydrous 151,00 [7785-87-7].

Manganese Sulfate contains not less than 98,0 percent and not more than 102,0 percent of $\text{MnSO}_4 \cdot \text{H}_2\text{O}$.

Packaging and storage— Preserve in tight containers. Store at 25, excursions permitted between 15 and 30.

Identification— A solution (1 in 10) responds to the tests for Manganese 191 and for Sulfate 191.

Loss on ignition – Ignite it at 450 to constant weight: it loses between 10,0 and 13,0% of its weight.

Substances not precipitated by ammonium sulfide– Dissolve 2,0 g in 90 mL of water, add 5 mL of ammonium hydroxide, warm the solution, and pass hydrogen sulfide through the solution for about 30 minutes. Dilute with water to 100 mL, mix, and allow the precipitate to settle. Decant the supernatant through a filter, transfer 50 mL of the clear filtrate to a tared dish, evaporate to dryness, and ignite, gently at first and finally at 800 ± 25 : the weight of the residue does not exceed 5 mg (0,5%).

Organic volatile impurities, Method I 467: meets the requirements. (Official until July 1, 2007).

Assay – Dissolve about 350 mg of Manganese Sulfate, accurately weighed, in 200 mL of water. Add about 10 mg of ascorbic acid, begin the titration by adding about 25 mL of 0,05 M edetate disodium VS, using a suitable buret, then add 10 mL of ammonia–ammonium chloride buffer TS, and about 0,15 mL of eriochrome black TS, and complete the titration with 0,05 M edetate disodium VS to a blue endpoint. Each mL of 0,05 M edetate disodium is equivalent to 8,451 mg of $\text{MnSO}_4 \cdot \text{H}_2\text{O}$.

Appendix 2

CHARACTERISTIC IR ABSORPTION FREQUENCIES OF ORGANIC FUNCTIONAL GROUPS

Functional Group	Type of Vibration	Characteristic absorptions (cm ⁻¹)	Intensity
Alcohol			
O–H	(stretch, H-bonded)	3200–3600	strong, broad
O–H	(stretch, free)	3500–3700	strong, sharp
C–O	(stretch)	1050–1150	strong
Alkane			
C–H	stretch	2850–3000	strong
–C–H	bending	1350–1480	variable
Alkene			
=C–H	stretch	3010–3100	medium
=C–H	bending	675–1000	strong
C=C	stretch	1620–1680	variable
Alkyl Halide			
C–F	stretch	1000–1400	strong
C–Cl	stretch	600–800	strong
C–Br	stretch	500–600	strong
C–I	stretch	500	strong
Alkyne			
C–H	stretch	3300	strong, sharp
–C≡C–	stretch	2100–2260	variable, not present in symmetrical alkynes
Amine			
N–H	stretch	3300–3500	medium (pri- mary amines have two

Functional Group	Type of Vibration	Characteristic absorptions (cm ⁻¹)	Intensity
			bands; secondary have one band, often very weak)
C–N	stretch	1080–1360	medium-weak
N–H	bending	1600	medium
Aromatic			
C–H	stretch	3000–3100	medium
C=C	stretch	1400–1600	medium-weak, multiple bands
Analysis of C-H out-of-plane bending can often distinguish substitution patterns			
Carbonyl	Detailed Information on Carbonyl IR		
C=O	stretch	1670–1820	strong
(conjugation moves absorptions to lower wave numbers)			
Ether			
C–O	stretch	1000–1300 (1070–1150)	strong
Nitrile			
CN	stretch	2210–2260	medium
Nitro			
N–O	stretch	1515–1560 & 1345–1385	strong, two bands
IR Absorption Frequencies of Functional Groups Containing a Carbonyl (C=O)			
Carbonyl			
C=O	stretch	1670–1820	strong
(conjugation moves absorptions to lower wave numbers)			
Acid			
C=O	stretch	1700–1725	strong
O–H	stretch	2500–3300	strong, very broad
C–O	stretch	1210–1320	strong

Continue

Functional Group	Type of Vibration	Characteristic absorptions (cm ⁻¹)	Intensity
Aldehyde			
C=O	stretch	1740–1720	strong
=C–H	stretch	2820–2850 & 2720–2750	medium, two peaks
Amide			
C=O	stretch	1640–1690	strong
N–H	stretch	3100–3500	unsubstituted have two bands
N–H	bending	1550–1640	
Anhydride			
C=O	stretch	1800–1830 & 1740–1775	two bands
Ester			
C=O	stretch	1735–1750	strong
C–O	stretch	1000–1300	two bands or more
Ketone			
acyclic	stretch	1705–1725	strong
cyclic	stretch	3-membered – 1850 4-membered – 1780 5-membered – 1745 6-membered – 1715 7-membered – 1705	strong
α-, β- unsaturated	stretch	1665–1685	strong
aryl ketone	stretch	1680–1700	strong

CONTENTS

PART I. Theory

Module 1. GENERAL QUESTIONS OF DRUG ANALYSIS AND QUALITY CONTROL	3
Topic 1. Common approaches for quality control of drugs. Harmonization of pharmacopoeias	3
Topic 2. Pharmaceutical analysis data treatment. Validation of analytical procedures	11
Module 2. PHYSICAL ANALYSIS FOR MEDICINES QUALITY CONTROL	23
Topic 3. Thermal analysis in leading pharmacopoeias. Melting point determination of API	23
Topic 4. Optical methods for medicines quality control. Polarimetry	30
Topic 5. Optical methods for medicines quality control. Refractometry	41
Module 3. WATER QUALITY CONTROL	51
Topic 6. Pharmacopoeial methods for water quality control. Methods for water determination in drugs	51
Module 4. CHEMICAL ANALYSIS FOR MEDICINES QUALITY CONTROL	59
Topic 7. Chemical analysis for medicines quality control. Precipitate and chromogenic reactions	59
Topic 8. Chemical analysis for medicines quality control. Pharmacopoeial titrimetric methods	69
Module 5. SPECTRAL ANALYSIS FOR DRUG QUALITY CONTROL	75
Topic 9. Ultraviolet (UV) and visible spectrophotometry for medicines quality control	75
Topic 10. Infrared (IR) spectroscopy for medicines quality control	93

Topic 11. Atomic absorption spectroscopy (AAS) for medicines quality control	105
--	-----

PART II. Laboratory Practice

Laboratory practice session 1. Common approaches for quality control of drugs. Harmonization of pharmacopoeias	120
Laboratory practice session 2. Pharmaceutical analysis data treatment. Validation of analytical procedures ...	131
Laboratory practice session 3. Thermal analysis in leading pharmacopoeias. Melting point determination of API	142
Laboratory practice session 4. Optical methods for medicines quality control. Polarimetry	148
Laboratory practice session 5. Optical methods for medicines quality control. Refractometry	157
Laboratory practice session 6. Pharmacopoeial methods for water quality control. Methods for water determination in drugs	165
Laboratory practice session 7. Chemical analysis for medicines quality control. Precipitate and chromogenic reactions	170
Laboratory practice session 8. Chemical analysis for medicines quality control. Pharmacopoeial titrimetric methods	184
Laboratory practice session 9. Ultraviolet (UV) and visible spectrophotometry for medicines quality control ...	190
Laboratory practice session 10. Infrared (IR) spectroscopy for medicines quality control	196
Laboratory practice session 11. Atomic absorption spectroscopy (AAS) for medicines quality control	203

REFERENCES AND FURTHER READING. WEBSITES	207
<i>Appendix 1. Pharmacopoeia articles for peer review</i>	209
<i>Appendix 2. Characteristic IR absorption frequencies of organic functional groups</i>	221